

**Door and fixed panel- wall-mount hinges / Porte et panneau fixe- charnières fixées au mur**



Model shown / Modèle présenté : Kara Inline / En alcôve (PLAKP57-11-40L-MA-79)

Base shown / Base présenté : Alessa (ASER6036-18-7)

**FEATURES / CARACTÉRISTIQUES :**

- ◆ European style frameless doors  
*Portes sans cadre de style européen.*
- ◆ Reversible right and left-opening door configuration  
*Ouverture de porte réversible à gauche ou à droite*
- ◆ Tempered glass  
*Verre trempé*
- ◆ Glass thickness : 3/8" (10mm)  
*Épaisseur du verre : 3/8" (10mm)*
- ◆ Microtek glass surface protection included  
*Protection de verre Microtek incluse*
- ◆ Multiple configurations available  
*Configurations multiples disponibles*
- ◆ Choice of hinges  
*Choix de charnières*
- ◆ Choice of handles  
*Choix de poignée*
- ◆ Available with towel bar  
*Disponible avec porte-serviette*
- ◆ 10-year limited warranty  
*Garantie limitée de 10 ans*
- ◆ Easy to install (see Instruction Manual)  
*Facile à installer (Voir le manuel d'instruction)*

 **Find a store near you**  
**Trouvez votre magasin le plus proche**

|  |  |  |   |
|--|--|--|---|
| <b>Project / Projet :</b><br><b>Contact :</b><br><b>Date :</b><br><b>Tel / Tél :</b> | Products and specifications are subject to change without notice. Please contact our sale office for any further enquiry.<br><br><i>Les produits et les caractéristiques peuvent être modifiés sans préavis. Pour toute demande de renseignements, veuillez communiquer avec notre service à la clientèle.</i> | <b>Glass Options / Verre</b><br>40 : Clear / Clair | <b>Finish Options / Fini</b><br>11 : Bright Chrome / Chrome brillant<br>25 : Brushed Nickel / Nickel brossé |
|  |  |  |   |

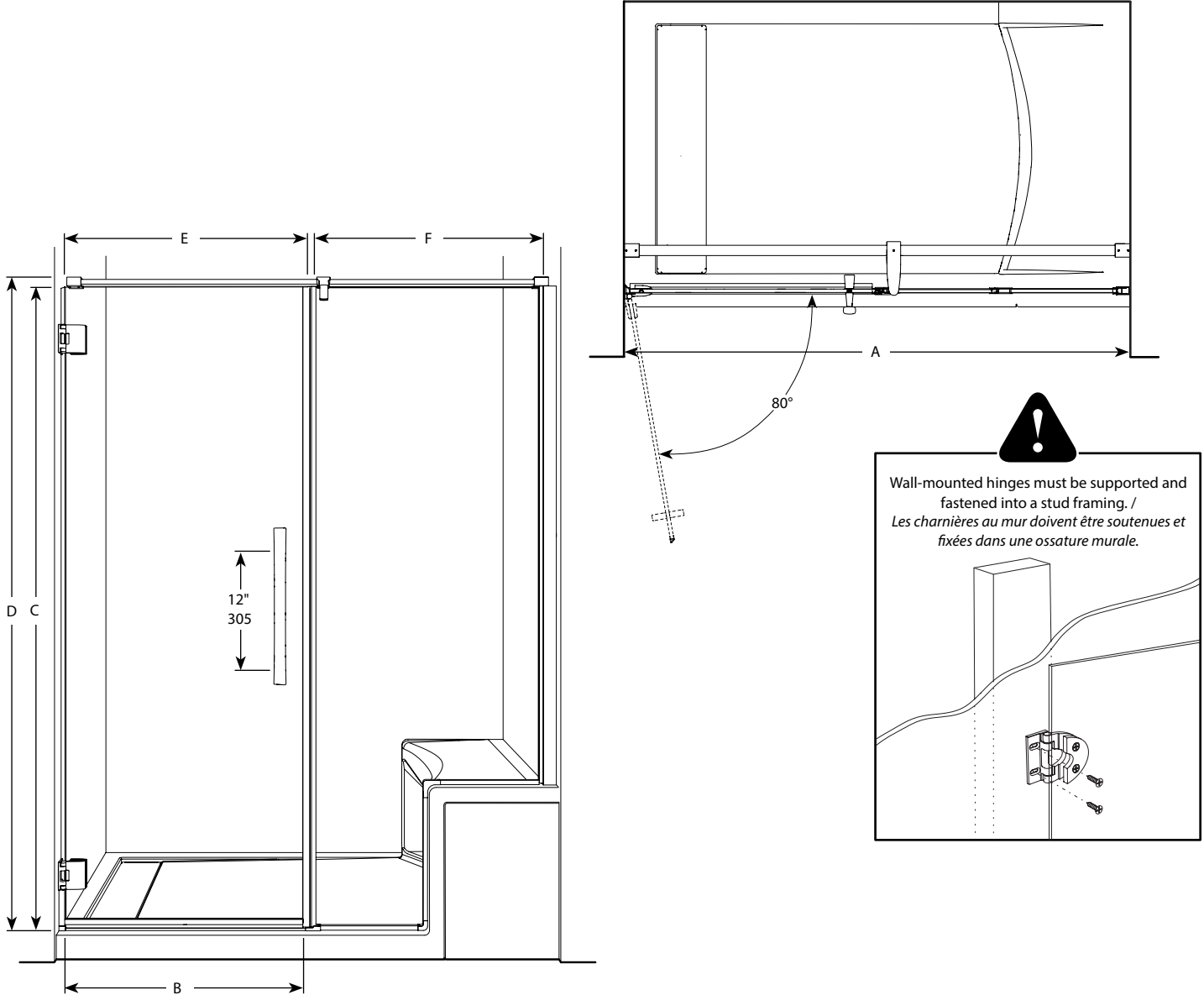

| Model<br>Modèle | Wall opening<br>Ouverture<br>(A)           | Approx. Entry Opening<br>Ouverture<br>entrée approx.<br>(B) | Height<br>Hauteur<br>(C) | Height to top of<br>support bar<br>Hauteur jusqu'au dessus de la<br>barre de soutien<br>(D) | Door Panel<br>Panneau de porte<br>(E) | Fixed panel<br>Panneau fixe<br>(F) | Base               |
|-----------------|--|---|--------------------------|---|---------------------------------------|------------------------------------|--------------------|
| PLAKP57         | 57 3/4" to/à 58 1/4"<br>1467mm to/à 1480mm | 28 1/2"<br>724mm  | 79"<br>2006mm            | 80 1/2"<br>2044mm   | 28 3/16" x 78 1/2"<br>716mm x 1993mm  | 26 3/4" x 79"<br>679mm x 2006mm    | ASEL6036, ASER6036 |

**Options**

|   |   |  |   |   |
|---|---|--|---|---|
| <p><b>Insert Code L or R</b><br/>Insérer le code L ou R</p> | <p><b>Insert Code M, Q, T or R</b><br/>Insérer le code M, Q, T ou R</p> | <p><b>Insert Code A, B, C, or D / Insérer le code A, B, C, ou D</b></p> <p><i>* Available in Polished Chrome (11) and Brushed Nickel (25)<br/>Disponible en Chrome (11) et en Nickel Brossé (25)</i></p> | <p>Towel Bar installs onto a Return Panel<br/>Le porte-serviette est fixé au panneau de côté</p> <p>Available in two FINISHES:<br/>Disponible en deux finis:<br/>CHROME / CHROME<br/>BRUSHED / BROSSÉ</p> | <p><b>Microtek</b> INCLUDED at no charge.<br/>by Fleurco<br/>Glass surface protection<br/>Protection du verre<br/><b>INCLUS sans frais.</b></p> |
|---|---|--|---|---|

|   |   |  |
|---|---|--|
| <p><b>Project / Projet :</b><br/> <b>Contact :</b><br/> <b>Date :</b><br/> <b>Tel / Tél :</b></p> | <p>Products and specifications are subject to change without notice. Please contact our sale office for any further enquiry.<br/> <i>Les produits et les caractéristiques peuvent être modifiés sans préavis. Pour toute demande de renseignements, veuillez communiquer avec notre service à la clientèle.</i></p> | <p><b>Base Color / Couleur de la base</b><br/> <b>18 : White / Blanc</b></p> |
|---|---|--|

**R**  
**RIGHT-SIDE CONFIGURATION**  
**DRAIN CÔTÉ DROIT**

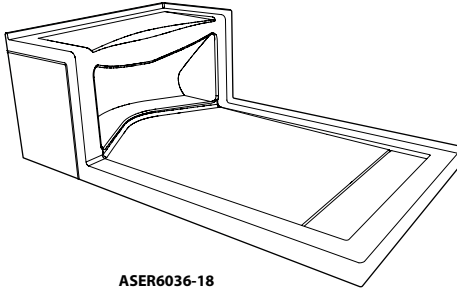

**L**  
**LEFT-SIDE CONFIGURATION**  
**DRAIN CÔTÉ GAUCHE**

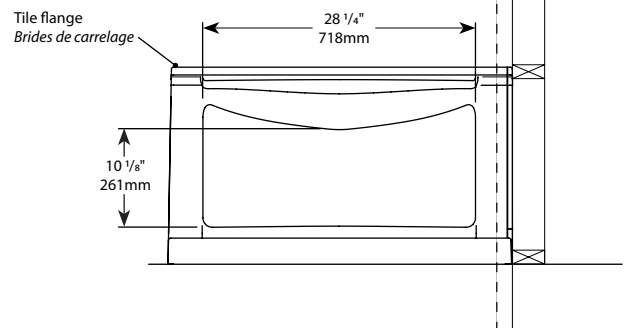
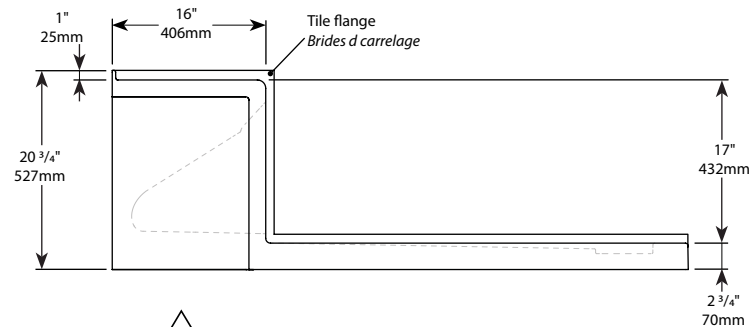
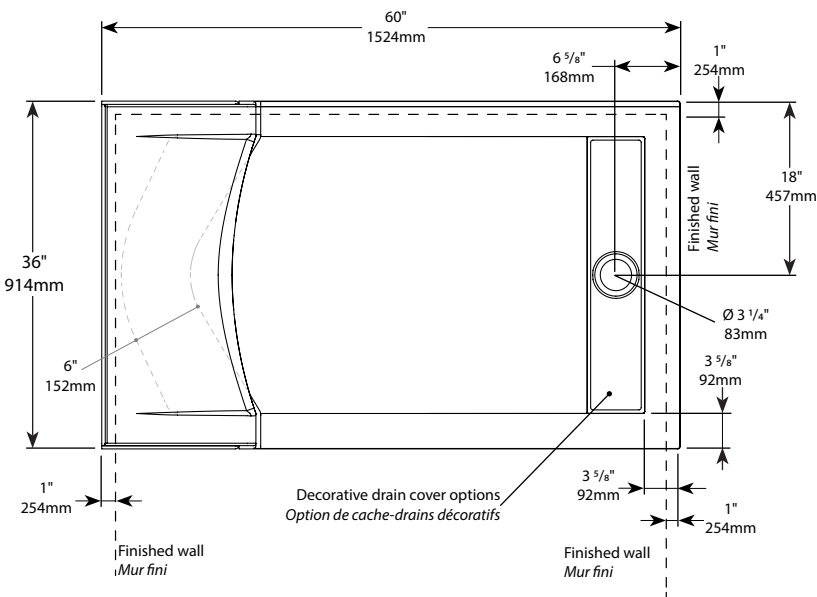
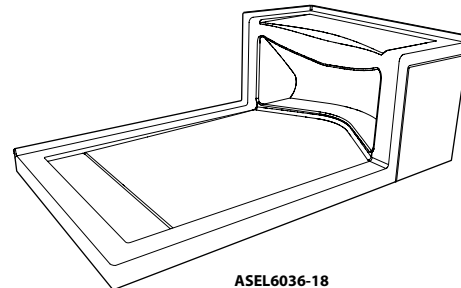

\*Tolerance ± 1/4" / 6mm