

KT Tub Enclosure / KT Baignoire

Sliding Door and fixed panel / *Porte coulissante et panneau fixe*



Model shown / *Modèle présenté* : Kinetik KT tub enclosure In-line / Kinetik KT baignoire (KT057-11-40L-A)

FEATURES / CARACTÉRISTIQUES :

- ◆ Technologically superior door construction
Construction de porte technologiquement supérieure
- ◆ Right or left space-saving sliding door panel
Ouverture coulissante (à droite ou à gauche) pour les espaces restreints
- ◆ Tempered glass
Verre trempé
- ◆ Glass thickness : 1/2" (12 mm)
Épaisseur du verre : 1/2" (12 mm)
- ◆ Choice of four handles
Choix de quatre poignées
- ◆ Solid stainless steel running rail
Rail solide en acier inoxydable
- ◆ Sealed stainless steel bearings
Roulettes scellées en acier inoxydable
- ◆ Microtek glass surface protection included
Protection du verre Microtek incluse
- ◆ Multiple configurations available
Configurations multiples disponibles
- ◆ 10-year limited warranty
Garantie limitée de 10 ans
- ◆ Easy to install (see Instruction Manual)
Facile à installer (Voir le manuel d'instruction)

 Find a store near you
Trouvez votre magasin le plus proche

Technical information / *Information technique*

Project / Projet : Contact : Date : Tel / Tél :	Glass Options / Verre 40 : Clear / Clair (1/2", 12 mm)	Finish Options / Fini 11 : Polished Stainless / Inox poli 35 : Brushed Stainless / Inox brossé

Microtek
by Fleurco

Glass surface protection
See information sheet at
the end of this section.

Protection du verre Microtek,
voir à la fin de la section pour
plus d'informations.

Top view / *Vue de dessus*

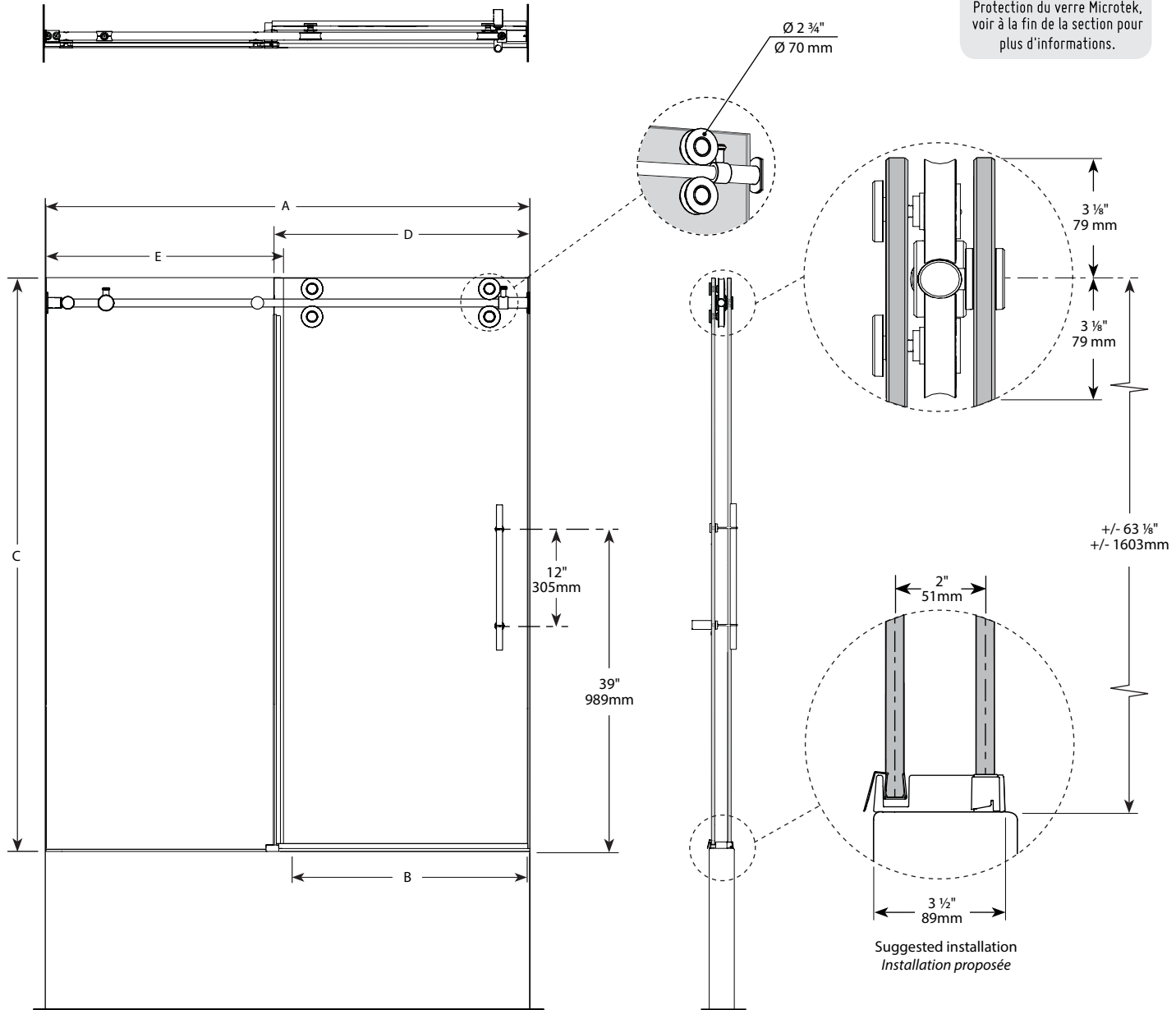
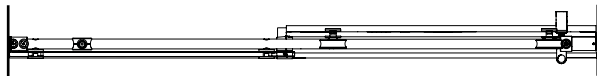

Front view / *Vue de face*

Side view / *Vue de côté*

Technical information / Information technique

Note:	Glass Options / Verre	Finish Options / Fini
	40 : Clear / Clair (1/2", 12 mm)	11 : Polished Stainless / Inox poli 35 : Brushed Stainless / Inox brossé

 It is mandatory to have a wall stud on each side of the shower unit to securely fasten the rail to the walls.
Il est nécessaire d'avoir une ossature murale sur chaque côté de la douche pour fixer la barre de roulement.

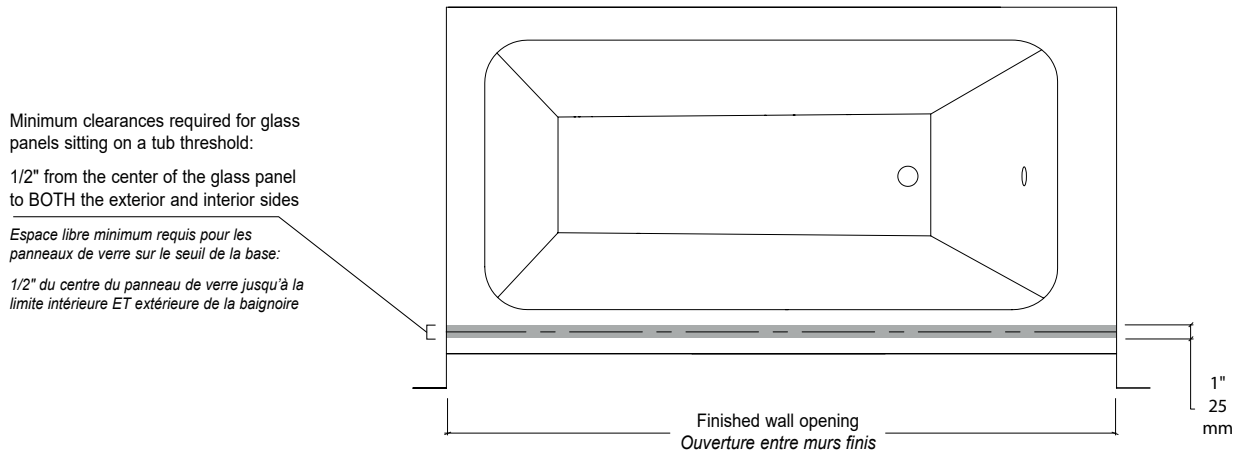

Model / Modèle	Wall Opening / Ouverture (A)	Approx. Entry Opening / Entrée (B)	Height / Hauteur (C)	Door Panel / Panneau de porte (D)	Fixed Panel / Panneau fixe (E)	Base
KT057	57" to/à 58 1/2" 1447mm to/à 1485mm	22" to/à 23 1/2" 559mm to/à 596mm	66" 1676mm	31 1/2" x 65 13/16" 800mm x 1672mm	29 1/2" x 66" 749mm x 1676mm	n/a
KT059	58 1/2" to/à 60" 1485mm to/à 1524mm	23" to/à 25 1/2" 584mm to/à 647mm	66" 1676mm	31 1/2" x 65 13/16" 800mm x 1672mm	29 1/2" x 66" 749mm x 1676mm	n/a

Options

Insert Code L or R / Insérer le code L ou R

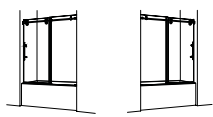

"L" "R"

Insert Code A, B, C, D or E / Insérer le code A, B, C, D ou E

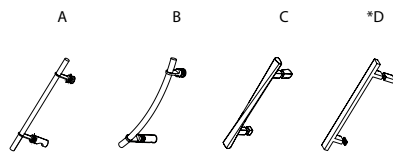

* Available in Polished Chrome (11) and Brushed Nickel (35)
* Disponible en chrome poli (11) et en nickel brossé (35)

Insert Code "H" for flat or "Y" for round to select OPTIONAL TOWEL BAR.
Insérer le code «H» pour plat ou «Y» pour rond pour l'OPTION PORTE-SERVIETTE.
Towel bar installs onto the fixed panel.
Le porte-serviette est installé au panneau fixe.

Available in Polished Chrome (11) and Brushed Nickel (35)
Disponible en chrome poli (11) et en nickel brossé (35)

Glass panel / Panneau de verre

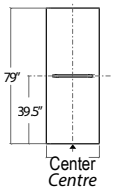

Center / Centre

