

**TOOLS REQUIRED
OUTILS REQUIS**

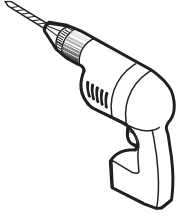

DRILL
PERCEUSE



1/4" & 1/8" DRILL BITS
MÈCHE 1/4" & 1/8"

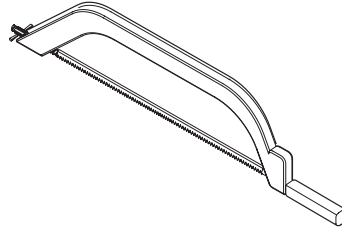

HACKSAW
SCIE À MÉTAUX

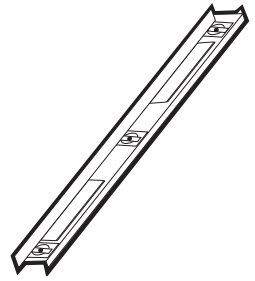

LEVEL
NIVEAU



PENCIL
CRAYON

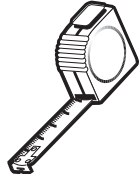

TAPE MEASURE
RUBAN À MESURER



SCREWDRIVER
TOURNEVIS

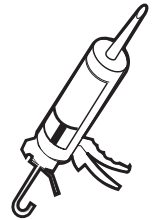

SILICONE
SCÉLLANT

*** Use a 1/4" drill bit for ceramic when drilling into ceramic tiles**
*** Utiliser une mèche de 1/4" destiné à céramique lors du perçage des tuiles en céramique.**

**POSSIBLE CONFIGURATIONS
CONFIGURATIONS POSSIBLES**

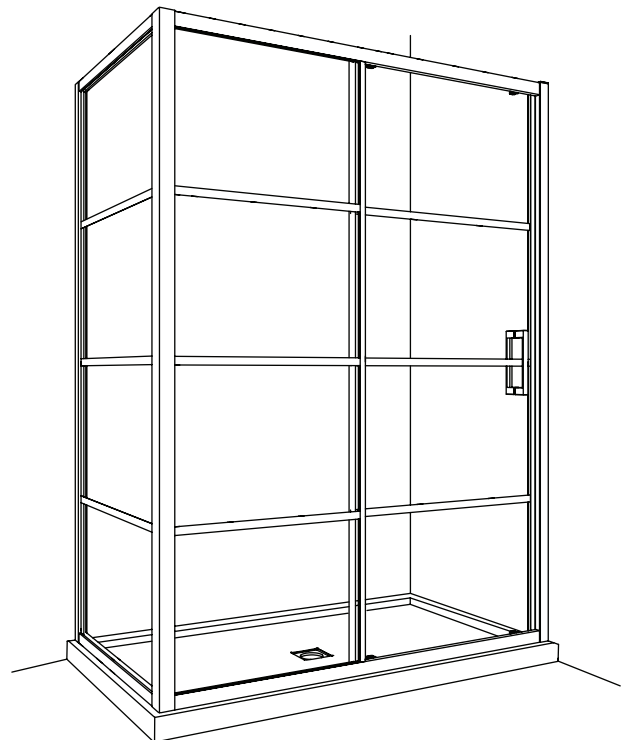
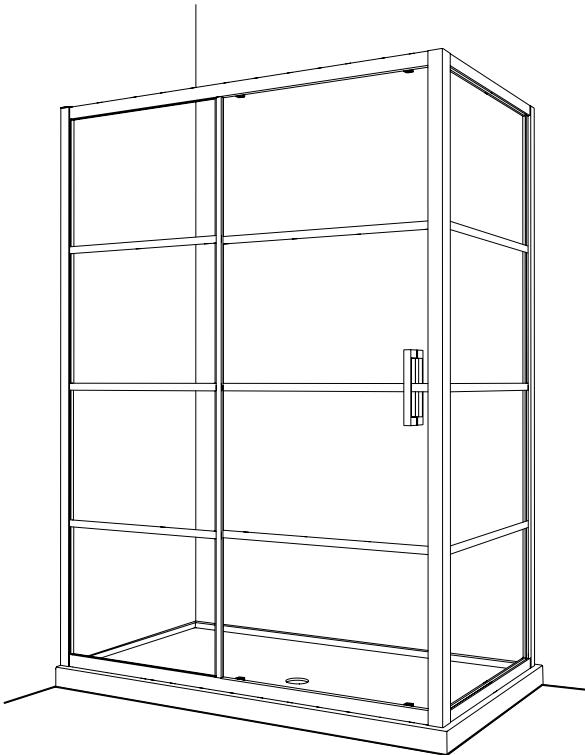

PARTS AND HARDWARE LISTING
LISTE DES PIÈCES ET QUINCAILLERIE

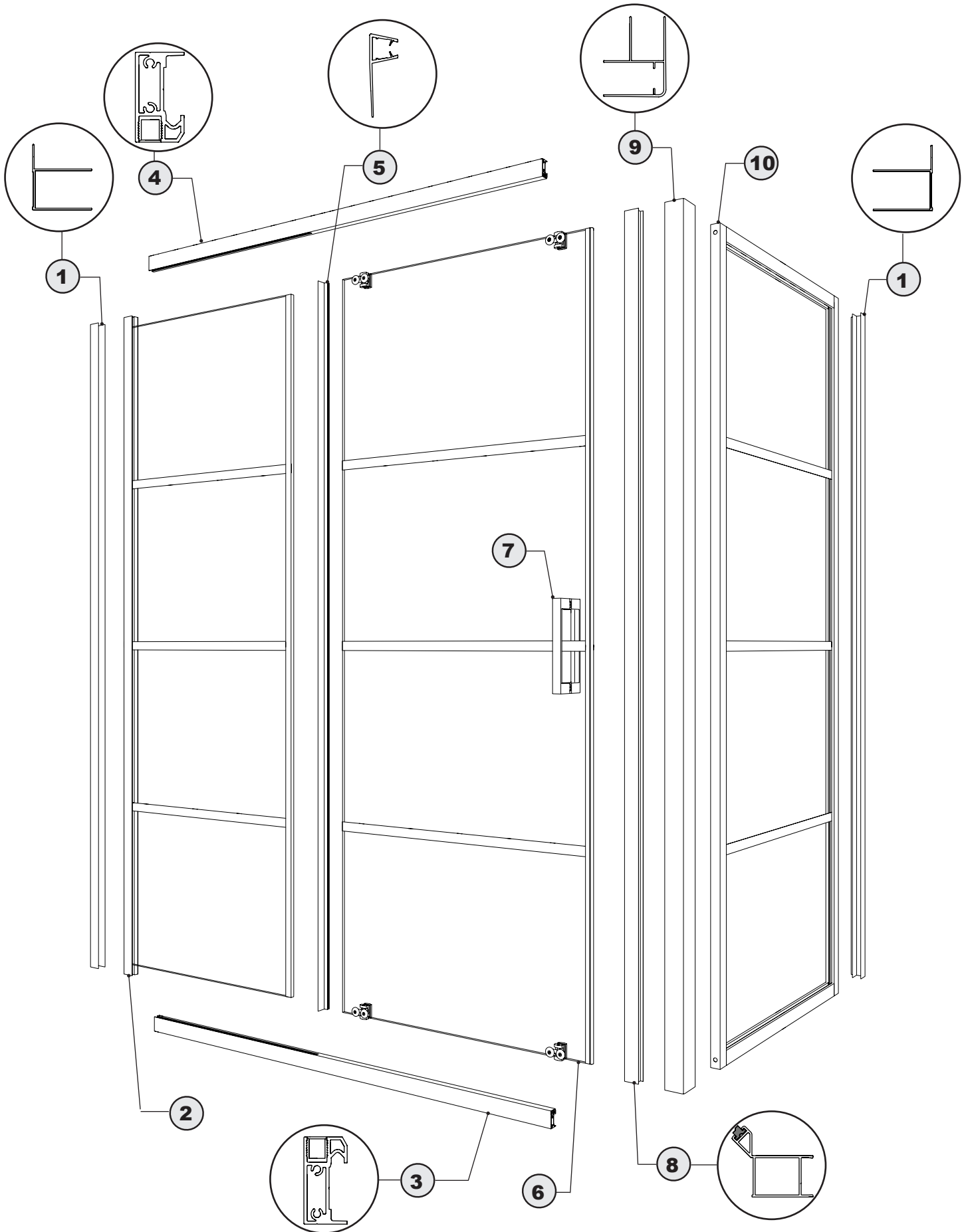

PARTS LISTING / LISTE DES PIÈCES

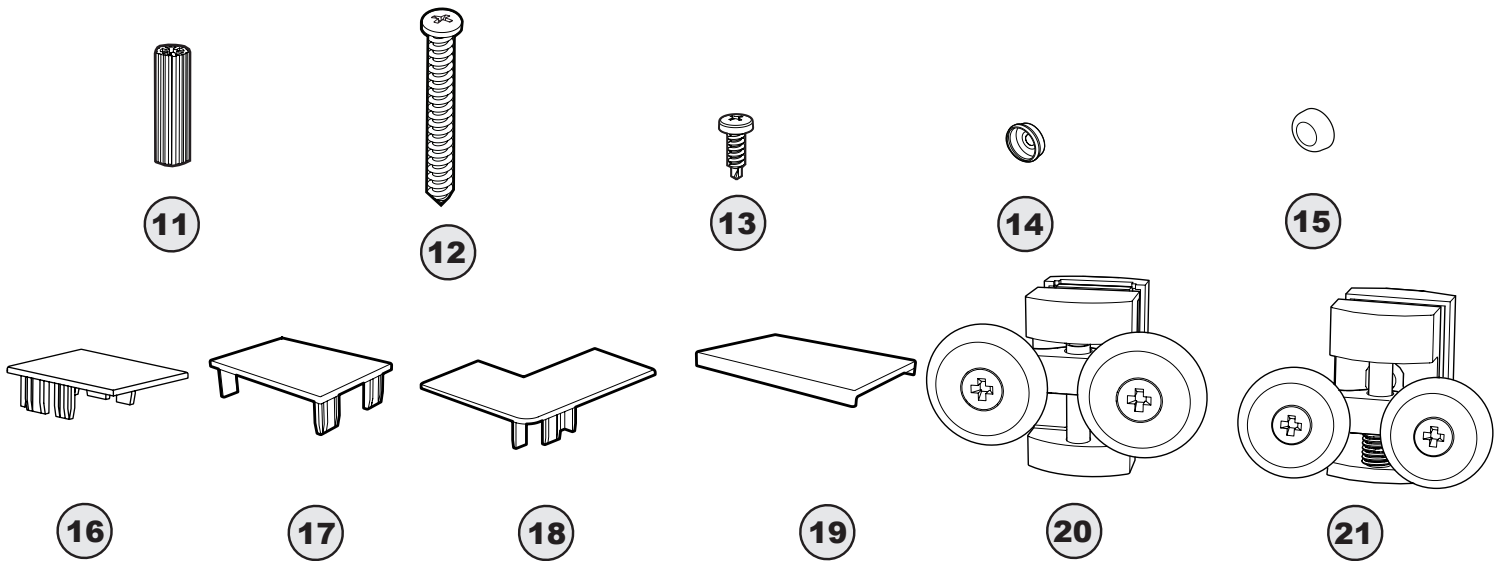

ITEM	FLEURCO CODE	PARTS AND HARDWARE / PIÈCES ET QUINCAILLERIE	QTY
1	LA-WJAMB-33-79	WALL JAMB / JAMBAGE	2
2		FIXED PANEL / PANNEAU FIXE	1
3	LA-RAIL-**-L	BOTTOM TRACK / RAIL DU BAS	1
4	LA-RAIL-**-R	TOP TRACK / RAIL DU HAUT	1
5	COEX LA100-79-33	SIDE GASKET / JOINT LATÉRAL DE LA PORTE	1
6		DOOR PANEL / PANNEAU DE PORTE	1
7		HANDLE / POIGNÉE	1
8	LA-MAGEXP-33-79	MAGNETIC EXPANDER / EXTENSEUR MAGNÉTIQUE	1
9	LA-CJAMB-33-79	CORNER JAMB / JAMBAGE DU COIN	1
10		RETURN PANEL / PANNEAU DE RETOUR	1
11		WALL PLUG / CHEVILLE	6
12		PAN HEAD SCREW / VIS À TÊTE CYLINDRIQUE	14
13		PAN SELF-DRILLING SCREW / VIS PAN AUTO-PERÇANTE	12
14		BACK SCREW CAP / CAPUCHON COUVRE-VIS ARRIERE	18
15		SCREW CAP / CAPUCHON COUVRE-VIS	18
16	LA-EXP-CAP-33-79	FRAME CAP FOR FIXED PANEL SIDE / CAPUCHON DU CADRE POUR DE CÔTÉ DU PANNEAU FIXE	1
17	LA-RP-CAP-33-79	FRAME CAP FOR RETURN PANEL SIDE / CAPUCHON DU CADRE POUR DE CÔTÉ DU PANNEAU DE RETOUR	1
18	LA-CJAMB-CAP-33-79	CORNER JAMB CAP / CAPUCHON DU JAMBAGE DU COIN	2
19	LA-WJCAP-33	WALL JAMB CAP / CAPUCHON DU JAMBAGE	2
20	LA-ROLLER-TOP-33	TOP WHEEL / ROULETTE DU HAUT	2
21	LA-ROLLER-BTM-33	BOTTOM WHEEL / ROULETTE DU BAS	2