

TOOLS REQUIRED / OUTILS REQUIS

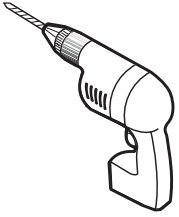

DRILL
PERCEUSE



1/4" & 1/8" DRILL BITS
MÈCHE 1/4" & 1/8"



SCREWDRIVER
TOURNEVIS

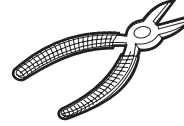

CUTTING PLIERS
PINCE COUPANTE

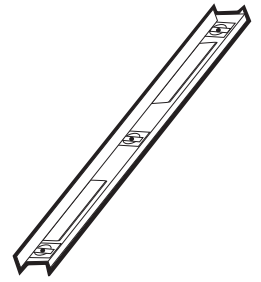

LEVEL
NIVEAU



PENCIL
CRAYON



TAPE MEASURE
RUBAN À MESURER



SAFETY GLASSES
LUNETTES DE SÉCURITÉ



MALLET
MAILLET

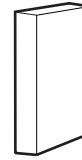

BLOCK
BLOC



WRENCH
CLÉ À FOURCHE

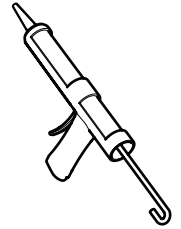

SILICONE
SCCELLANT

* Use a 1/4" drill bit for ceramic when drilling into ceramic tiles

* Utiliser une mèche de 1/4" destiné à céramique lors du perçage des tuiles en céramique.

POSSIBLE CONFIGURATIONS / CONFIGURATIONS POSSIBLES

SHOWER / DOUCHE

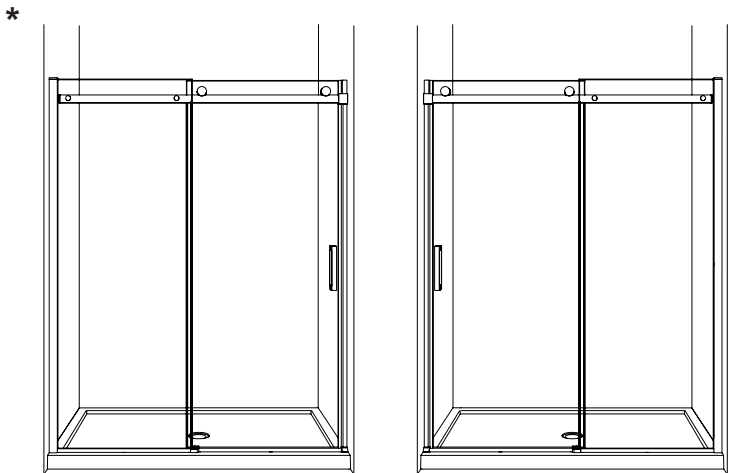

TUB / BAIGNOIRE

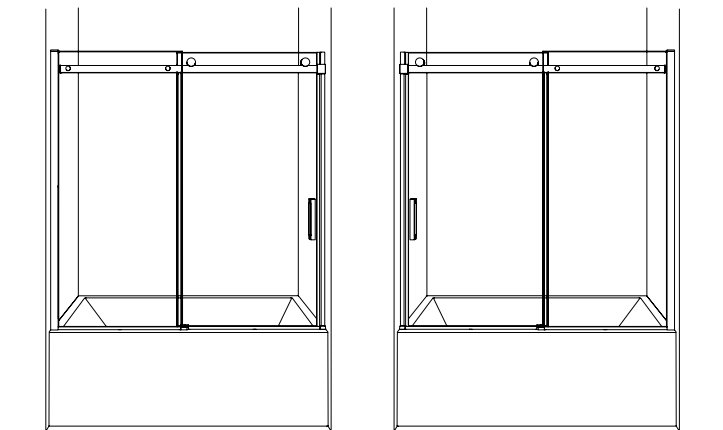



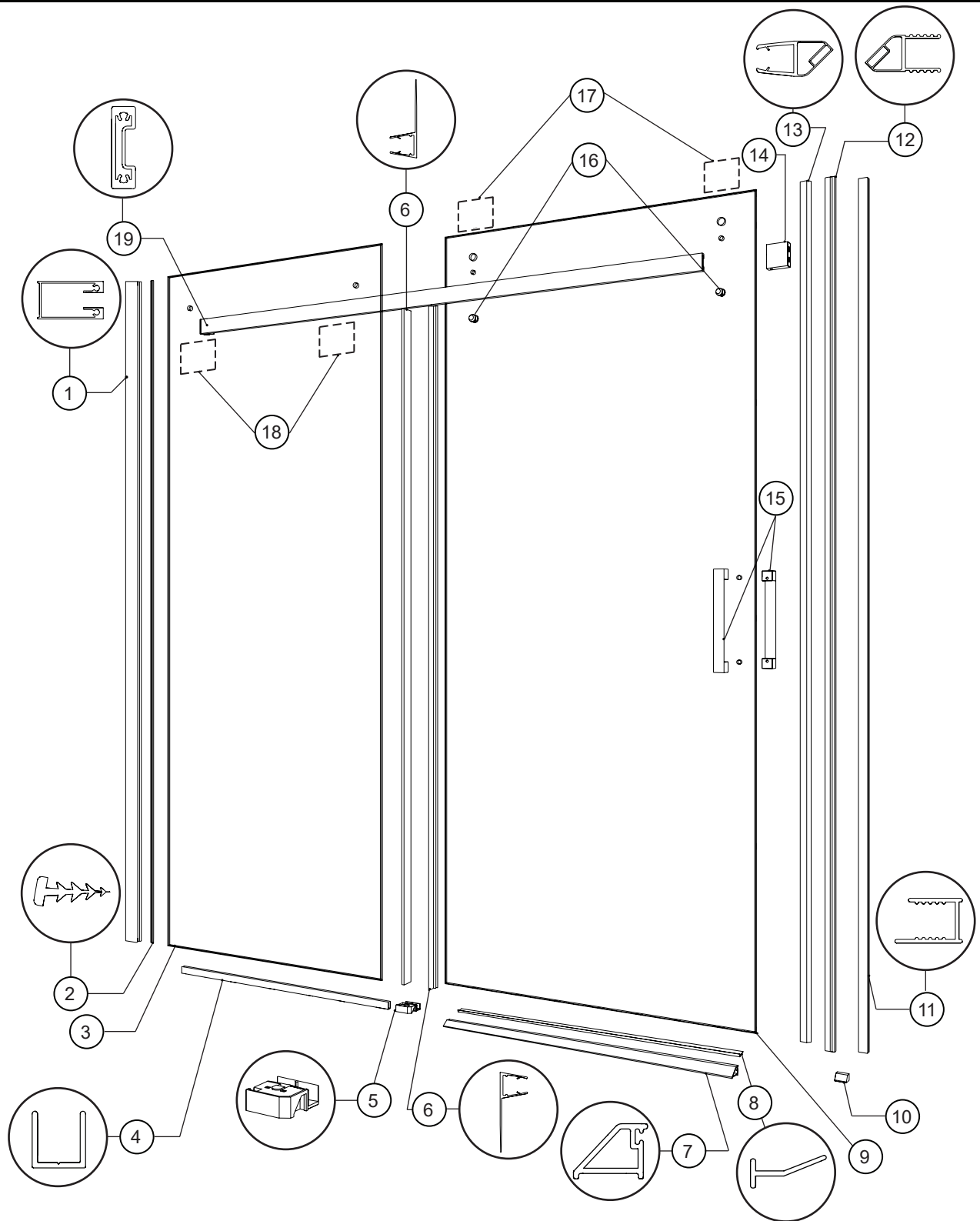

* THIS CONFIGURATION IS ILLUSTRATED IN THIS MANUAL. FOLLOW THE SAME STEPS FOR THE TUB.

* CETTE CONFIGURATION EST ILLUSTRÉE DANS CE MANUEL. SUIVRE LES MÊMES ÉTAPES POUR LA BAIGNOIRE.

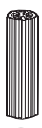
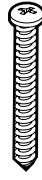
PARTS LISTING / LISTE DES PIÈCES

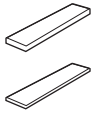
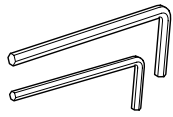
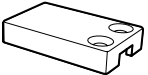
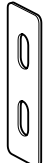

- 20 
- 21 
- 22 
- 23 
- 24 
- 25 
- 26 
- 27 
- 28 
- 29 

HARDWARE LISTING / LISTE DE QUINCAILLERIE

ITEM	FLEURCO CODE	PARTS LISTING / LISTE DES PIÈCES	QTY
1	NH/S-WJAMB-XX	WALLJAMB / JAMBAGE	1
2	VINYL-NH-S-86	WALL JAMB GASKET / JOINT DU JAMBAGE	1
3		FIXED PANEL / PANNEAU FIXE	1
4	NH/S-UCHANNEL-42-XX-1	U-CHANNEL FOR FIXED PANEL / PROFILÉ EN «U» POUR PANNEAU FIXE	1
5	NH/S-B-GUIDE-XX(R)(L)	BOTTOM GUIDE / GUIDE INFÉRIEUR	1
6	COEX HS100-81	MID GASKET FOR DOOR PANEL AND FIXED PANEL / JOINT LATÉRAL POUR LE PANNEAU DE PORTE ET PANNEAU FIXE	2
7	NH/S-THRESHOLD-34-XX	THRESHOLD / SEUIL	1
8	COEX HS110-33	THRESHOLD GASKET / JOINT DU SEUIL	1
9		DOOR PANEL / PANNEAU DE PORTE	1
10	NH/S-ENDCAP-XX	THRESHOLD ANCHOR / L'ANCRAGE DE SEUIL	1
11	NH/S-WCHANNEL-XX	WALLJAMB FOR DOOR PANEL / JAMBAGE POUR LE PANNEAU DE PORTE	1
12	MAGNET-NH-S-86	MAGNETIC GASKET FOR CHANNEL / JOINT MAGNÉTIQUE POUR PROFIL	1
13	MAGNET-NH-D-8-IN-86	ANGLED MAGNETIC SIDE DOOR GASKET / JOINT LATÉRAL MAGNÉTIQUE EN ANGLE DE LA PORTE	1
14	NH/S-BRACKET-XX	WALL MOUNT BRACKET / SUPPORT MURAL	1
15	NH/S-HANDLE-XX	DOOR HANDLE / POIGNÉE DE PORTE	1
16	NH/S-ANTIJUMP-XX	ANTI-JUMP / ANTI-SAUT	2
17		ROLLER (see chart below) / ROULETTE (voir le tableau ci-dessous)	2
18		GLASS FASTENER (see chart below) / FIXATION DE VERRE (voir le tableau ci-dessous)	2
19	NH/S-BAR-ASSY	RUNNING RAIL / BARRE DE ROULEMENT	1
ITEM	HARDWARE LISTING / LISTE DE QUINCAILLERIE		QTY
20		WALL PLUG / CHEVILLE	9
21		PAN HEAD SCREW / VIS À TÊTE CYLINDRIQUE	7
22		FLAT HEAD SELF-TAPPING SCREW / VIS AUTO TARAUDAGE À TÊTE PLATE	2
23		FLAT HEAD SELF-TAPPING SCREW / VIS AUTO TARAUDAGE À TÊTE PLATE	2
24		FASTENER CAPS / CAPUCHON DE FIXATION	2
25		ROLLER CAPS / CAPUCHON DE ROULETTE	2
26		CLEAR SETTING BLOCK (2 X 1/16" & 2 X 1/8") / BLOC À NIVEAU TRANSPARENT (2 X 1/16" & 2 X 1/8")	8
27		HEX KEY / CLÉ HEXAGONALE	2
28	NH/S-WJAMBCAP-XX	WALLJAMB CAP / CAPUCHON DU JAMBAGE	1
29		WALL MOUNT BRACKET GASKET / JOINT DU SUPPORT MURAL	1

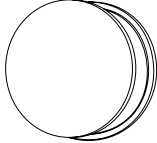
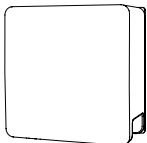
17 ROLLER OPTIONS / SÉLECTION DES ROULETTE	
A	B
	
NH-ROLLER-XX	NS-ROLLER-XX

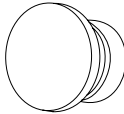
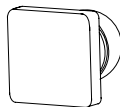
18 FASTENER OPTIONS / SÉLECTION DES FIXATION	
C	D
	
NH-FASTENER-XX	NS-FASTENER-XX

LEGEND / LÉGENDE
 XX = FINISH/FINI (11, 25, 33)
 ** = LENGTH / LONGUEUR (54, 60, 79, 86 ETC)
 ++ = CODE / CODE (AC, ABN)