

# PARTS LISTING / LISTE DES PIÈCES

## POSSIBLE CONFIGURATIONS / CONFIGURATIONS POSSIBLES

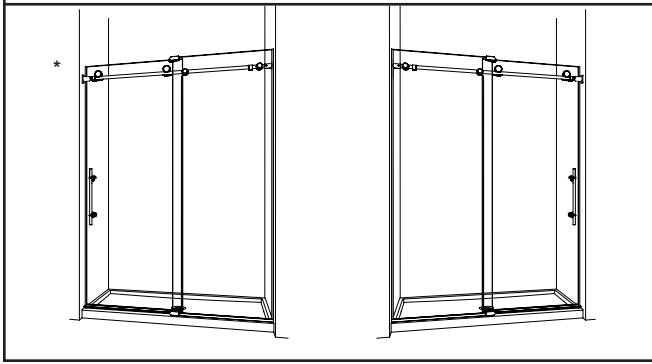

\* This configuration illustrated in this manual.  
 \* Cette configuration est illustrée dans ce manuel.

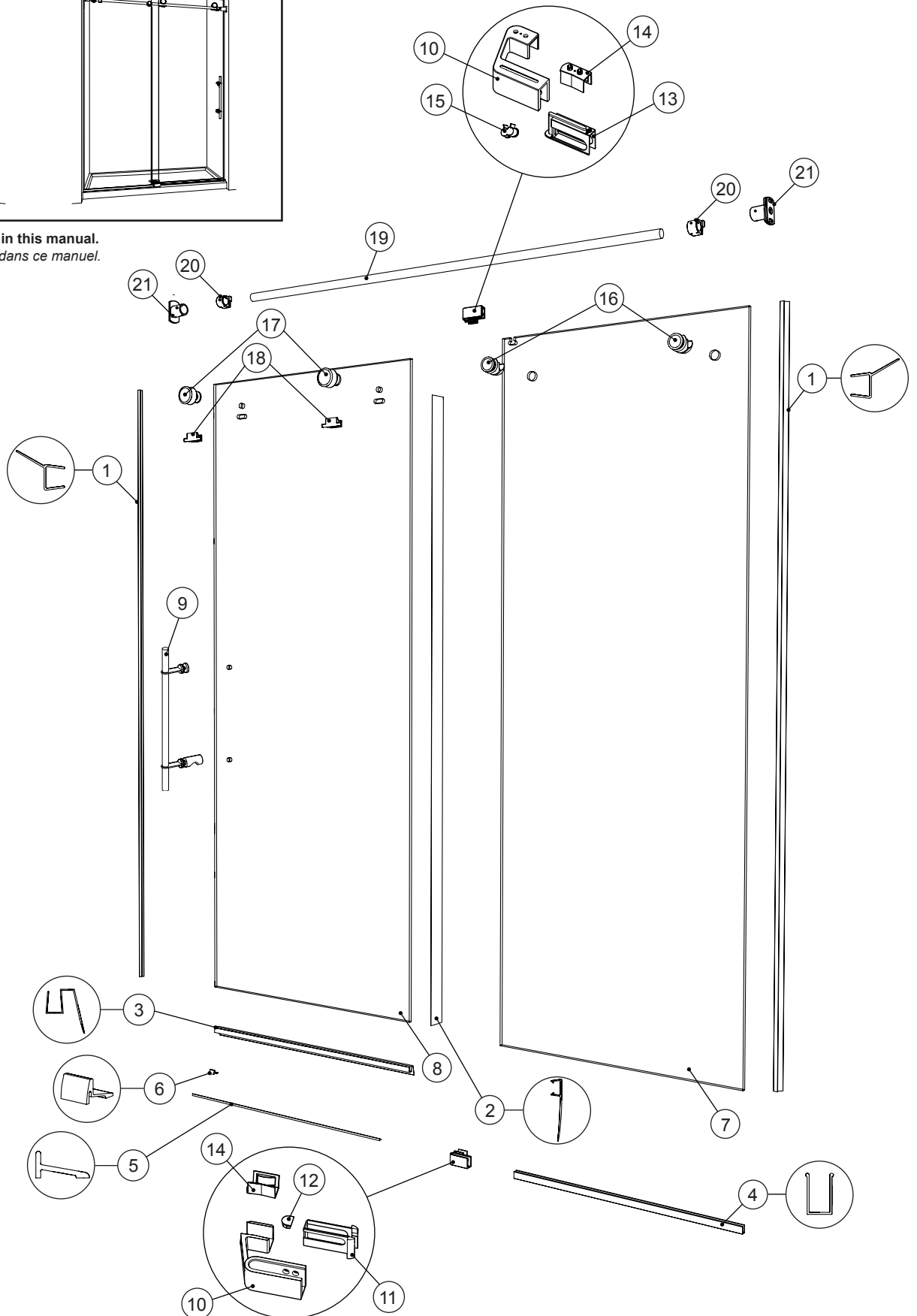

**PARTS LISTING / LISTE DES PIÈCES**

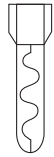

22



23

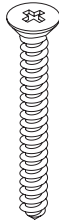

24

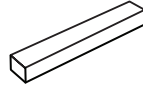

25

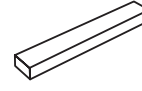

26

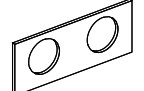

27

ITEM	PARTS AND HARDWARE / PIÈCES ET QUINCAILLERIE	QTY
1	SIDE GASKET / JOINT DE CÔTÉ	2
2	MID GASKET / JOINT LATÉRAL	1
3	BOTTOM DOOR GASKET / JOINT INFÉRIEUR DE LA PORTE	1
4	U-CHANNEL / PROFILÉ EN "U"	1
5	THRESHOLD / SEUIL	1
6	THRESHOLD ANCHOR / ANCRAGE DU SEUIL	1
7	FIXED PANEL / PANNEAU FIXE	1
8	DOOR PANEL / PANNEAU DE PORTE	1
9	HANDLE ( see chart above ) / POIGNÉE ( voir le tableau ci-dessus )	1
10	GUIDE / GUIDE	2
11	BOTTOM SLEEVE / GAINÉ PROTECTRICE INFÉRIEURE	1
12	GUIDE CAP / CAPUCHON DU GUIDE	1
13	TOP SLEEVE / GAINÉ PROTECTRICE SUPÉRIEURE	1
14	PLASTIC GUIDE / GUIDE EN PLASTIQUE	2
15	SCREW INSERT / INSERT DE VIS	1
16	GLASS FASTENER / FIXATION DE VERRE	2
17	ROLLER / ROULETTE	2
18	ANTI-JUMP / ANTI-SAUT	2
19	RUNNING RAIL / BARRE DE ROULEMENT	1
20	STOPPER / BUTOIR	2
21	WALL BRACKET / SUPPORT MURAL	2
22	WALL PLUG / CHEVILLE	4
23	FLAT SELF-DRILLING SCREW #6 (1") / VIS PLAT AUTO-PERÇANTE # 6 (1")	1
24	FLAT HEAD SCREW #10 (2 1/2") / VIS À TÊTE PLATE # 10 (2 1/2")	4
25	CLEAR SETTING BLOCK (5/32") / BLOC NIVEAU TRANSPARENT (5/32")	4
26	CLEAR SETTING BLOCK (1/8") / BLOC NIVEAU TRANSPARENT (1/8")	4
27	ANTI-JUMP SHIM / CALE POUR L'ANTI-SAUT	2