

TOOLS REQUIRED / OUTILS REQUIS

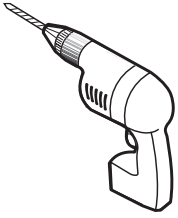

DRILL
PERCEUSE

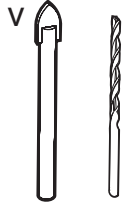

1/4" & 1/8" DRILL BITS
MÈCHE 1/4" & 1/8"



SCREWDRIVER
TOURNEVIS

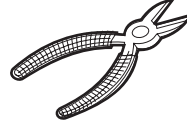

CUTTING PLIERS
PINCE COUPANTE

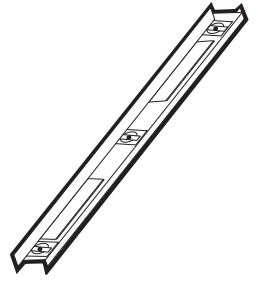

LEVEL
NIVEAU



PENCIL
CRAYON

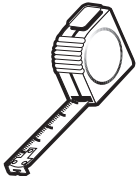

TAPE MEASURE
RUBAN À MESURER

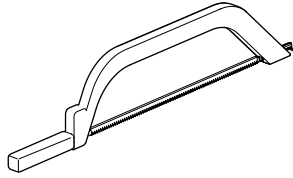

HACKSAW
SCIE À MÉTAUX



SAFETY GLASSES
LUNETTES DE SÉCURITÉ



MALLET
MAILLET



BLOCK
BLOC

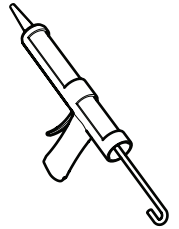

SILICONE
SCCELLANT

* Use a 1/4" drill bit when drilling into ceramic tiles
* Utiliser une mèche de 1/4" pour percer des tuiles en céramique.

POSSIBLE CONFIGURATIONS / CONFIGURATIONS POSSIBLES

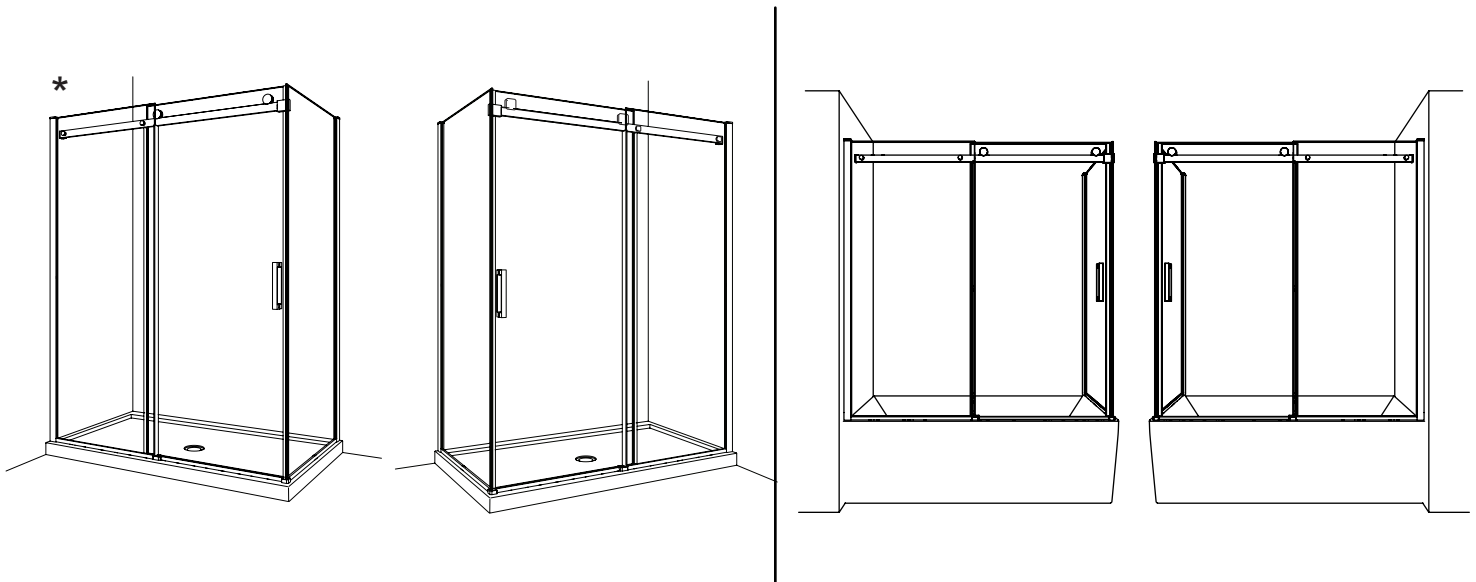

* This configuration illustrated in this manual. * Cette configuration est illustrée dans ce manuel.

DETECTING THE S.R.T SIDE ON THE GLASS / DÉTECTER LE CÔTÉ S.R.É SUR LE VERRE

The panels are treated differently on each side. Locate the Microtek and S.R.T label that is installed on the MICROTEK side (the INTERIOR side of the shower). Remove the sticker at the end of the installation.

Les panneaux ont un traitement différent sur chaque côté. Localiser l'étiquette Microtek et S.R.É qui est installée sur le côté du MICROTEK (la face INTÉRIEURE de la douche). Retirer l'étiquette à la fin de l'installation.

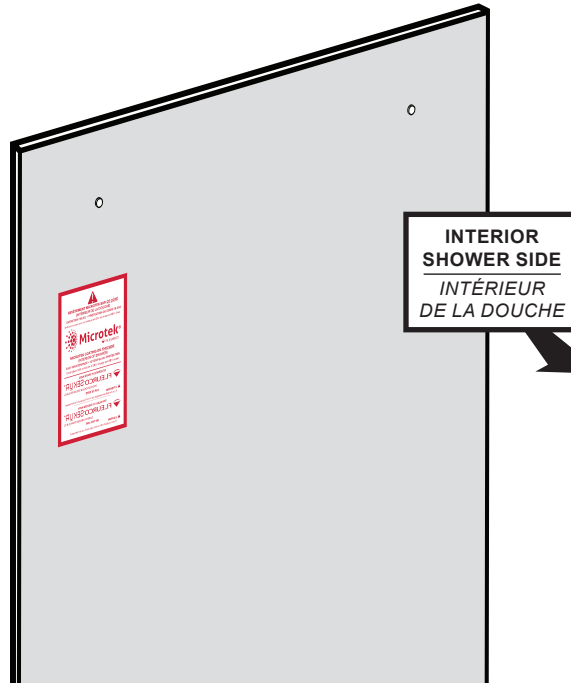

CONFIGURATION LISTING / LISTE DE CONFIGURATION

Please cross-check the labels from the packaging with the codes below as well as the corresponding bottom guide to ensure you have the correct products.

Veillez vérifier que les étiquettes de la boîte d'emballage correspondent aux codes suivants ainsi que le guide inférieur concerné pour s'assurer d'avoir les bons produits.

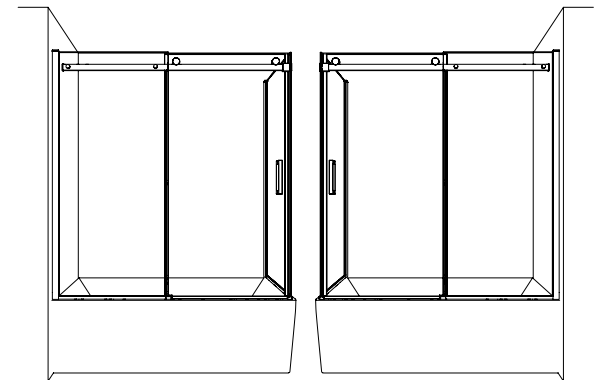
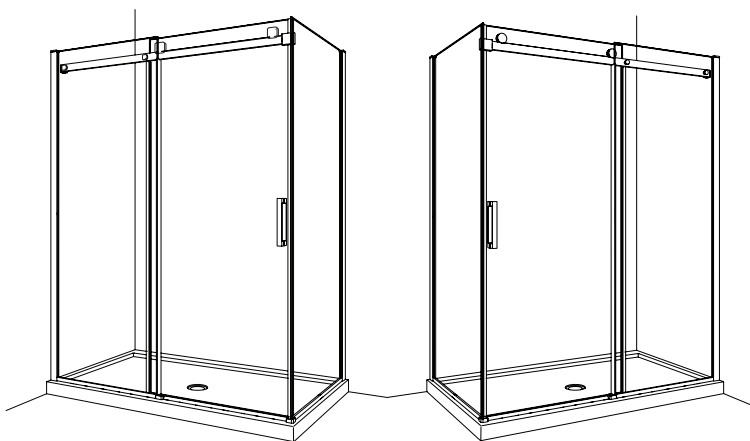

HORIZON NHS2_R_R-__40-__

NHS2_L_L-__40-__

NHST2_R32R-__40

NHST2_L32L-__40

SKYLINE NSS2_R_R-__40-__

NSS2_L_L-__40-__

NSST2_R32R-__40

NSST2_L32L-__40

RIGHT CONFIGURATION / CONFIGURATION À DRIOT

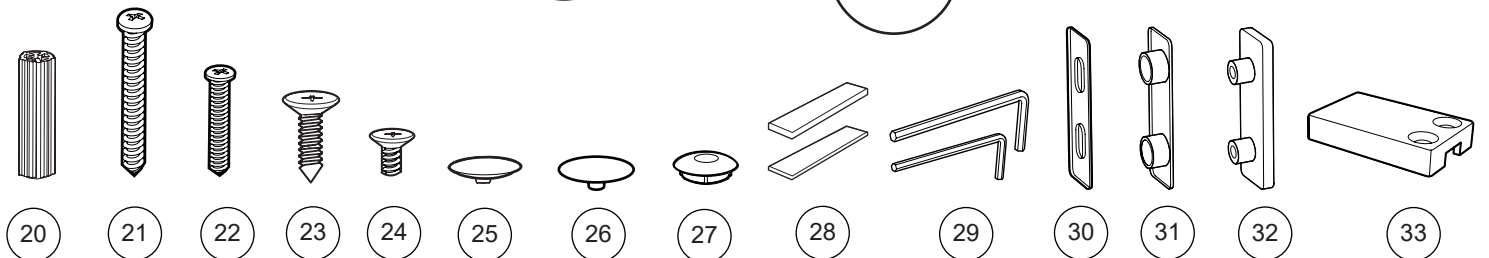
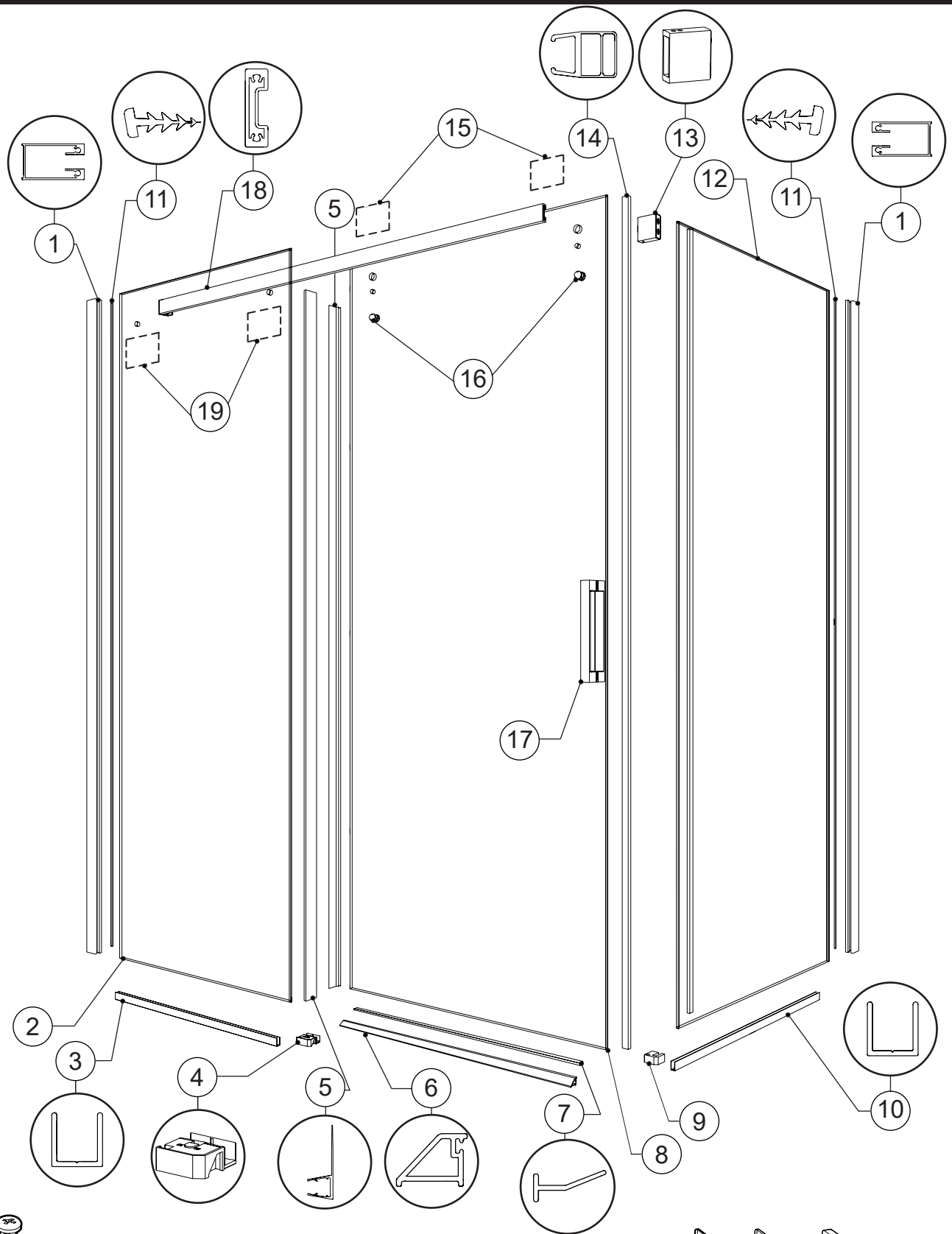

LEFT CONFIGURATION / CONFIGURATION À GAUCHE

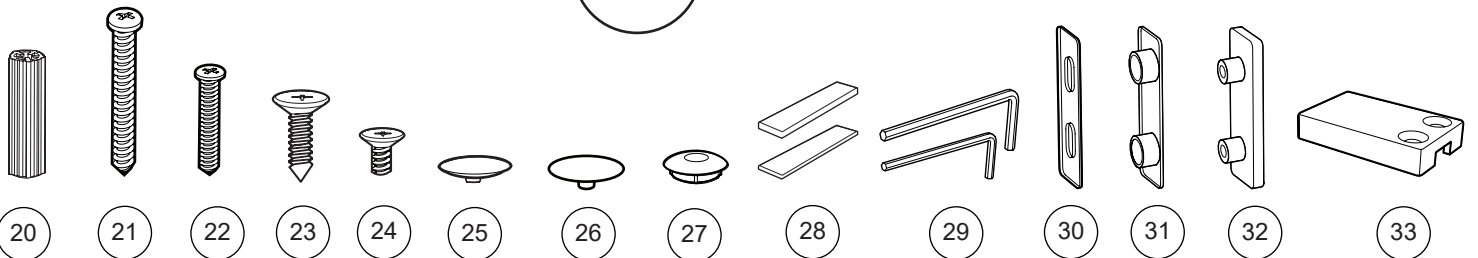
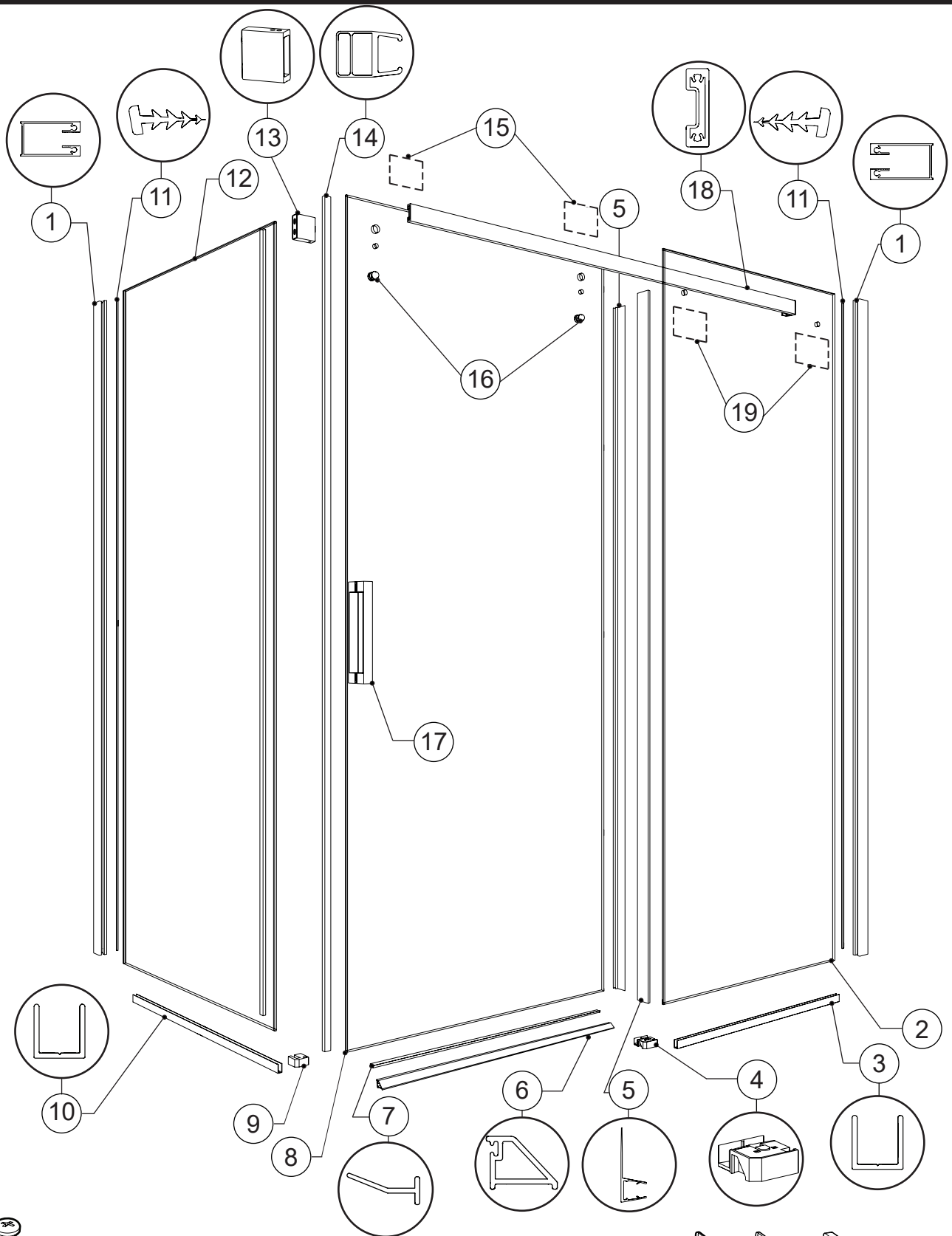

RIGHT CONFIGURATION PART LISTING / LISTE DE PIÈCES POUR COFIGURATION À DROIT

ITEM	FLEURCO CODE	PARTS LISTING / LISTE DES PIÈCES	QTY
1	NH/S-WJAMB-XX	WALLJAMB / JAMBAGE	1
2		FIXED PANEL / PANNEAU FIXE	1
3	NH/S-UCHANNEL-42-XX-1	U-CHANNEL FOR FIXED PANEL / PROFILÉ EN «U» POUR PANNEAU FIXE	1
4	NH/S-B-GUIDE-XXR	BOTTOM GUIDE / GUIDE INFÉRIEUR	1
5	COEX HS100-81	MID GASKET FOR DOOR PANEL AND FIXED PANEL / JOINT LATÉRAL POUR LE PANNEAU DE PORTE ET PANNEAU FIXE	2
6	NH/S-THRESHOLD-34-XX	THRESHOLD / SEUIL	1
7	COEX HS110-33	THRESHOLD GASKET / JOINT DU SEUIL	1
8		DOOR PANEL / PANNEAU DE PORTE	1
9	NH/S-UTELBOW-XX	CORNER ANCHOR / ANCRAGE DU COIN	1
10	NH/S-UCHANNEL-42-XX-1	U-CHANNEL FOR RETURN PANEL / PROFILÉ EN «U» POUR PANNEAU DE RETOUR	1
11	VINYL-NH-S-86	WALL JAMB GASKET / JOINT DU JAMBAGE	2
12		RETURN PANEL / PANNEAU DE RETOUR	1
13	NH/S-BRACKET-XX	WALL MOUNT BRACKET / SUPPORT MURAL	1
14	MAGNET-NH-D-8-RP-86	FLAT MAGNETIC SIDE DOOR GASKET / JOINT LATÉRAL MAGNÉTIQUE PLAT DE LA PORTE	1
	MAGNET-NH-D-8-RP-86-33		
15		ROLLER (see chart below) / ROULETTE (voir le tableau ci-dessous)	1
16	NH/S-ANTIJUMP-XX	ANTI-JUMP / ANTI-SAUT	1
17	NH/S-HANDLE-XX	DOOR HANDLE / POIGNÉE DE PORTE	1
18	NH/S-BAR-ASSY-**-XX	RUNNING RAIL / BARRE DE ROULEMENT	1
19		GLASS FASTENER (see chart below) / FIXATION DE VERRE (voir le tableau ci-dessous)	2
ITEM	HARDWARE LISTING / LISTE DE QUINCAILLERIE		QTY
20		WALL PLUG / CHEVILLE	8
21		PAN HEAD SCREW / VIS À TÊTE CYLINDRIQUE	6
22		PAN HEAD SCREW / VIS À TÊTE CYLINDRIQUE	2
23		FLAT HEAD SELF-TAPPING SCREW / VIS AUTO TARAUDAGE À TÊTE PLATE	4
24		FLAT HEAD SELF-TAPPING SCREW / VIS AUTO TARAUDAGE À TÊTE PLATE	2
25		FASTENER CAPS / CAPUCHON DE FIXATION	2
26		ROLLER CAPS / CAPUCHON DE ROULETTE	2
27		CORNER ANCHOR CAP / CAPUCHON D' ANCRAGE DU COIN	1
28		CLEAR SETTING BLOCK (4 X 1/32" & 4 X 1/8") / BLOC À NIVEAU TRANSPARENT (4 X 1/32" & 4 X 1/8")	8
29		HEX KEY / CLÉ HEXAGONALE	2
30		INTERIOR WALL MOUNT BRACKET GASKET / JOINT INTÉRIEUR DU SUPPORT MURAL	1
31		EXTERIOR WALL MOUNT BRACKET GASKET / JOINT EXTÉRIEUR DU SUPPORT MURAL	1
32		WALL MOUNT BRACKET FOR RETURN PANEL / SUPPORT MURAL POUR PANNEAU DE RETOUR	1
33	NH/S-WJAMBCAP-XX	WALLJAMB CAP / CAPUCHON DU JAMBAGE	2

15 ROLLER OPTIONS / SÉLECTION DES ROULETTE

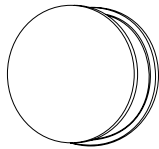
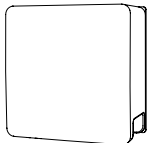
A	B
	
NH-ROLLER-XX	NS-ROLLER-XX

19 FASTENER OPTIONS / SÉLECTION DES FIXATION

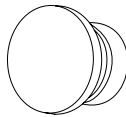
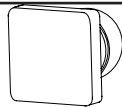
C	D
	
NH-FASTENER-XX	NS-FASTENER-XX

LEGEND / LÉGENDE
 XX = FINISH / FINI (11, 25, 33)
 ** = LENGTH / LONGUEUR (54, 60, 79, 86 ETC)
 ++ = CODE / CODE (AC, ABN)

LEFT CONFIGURATION PART LISTING / LISTE DE PIÈCES POUR COFIGURATION À GAUCHE

ITEM	FLEURCO CODE	PARTS LISTING / LISTE DES PIÈCES	QTY
1	NH/S-WJAMB-XX	WALLJAMB / JAMBAGE	1
2		FIXED PANEL / PANNEAU FIXE	1
3	NH/S-UCHANNEL-42-XX-1	U-CHANNEL FOR FIXED PANEL / PROFILÉ EN «U» POUR PANNEAU FIXE	1
4	NH/S-B-GUIDE-XXL	BOTTOM GUIDE / GUIDE INFÉRIEUR	1
5	COEX HS100-81	MID GASKET FOR DOOR PANEL AND FIXED PANEL / JOINT LATÉRAL POUR LE PANNEAU DE PORTE ET PANNEAU FIXE	2
6	NH/S-THRESHOLD-34-XX	THRESHOLD / SEUIL	1
7	COEX HS110-33	THRESHOLD GASKET / JOINT DU SEUIL	1
8		DOOR PANEL / PANNEAU DE PORTE	1
9	NH/S-UTELBOW-XX	CORNER ANCHOR / ANCRAGE DU COIN	1
10	NH/S-UCHANNEL-42-XX-1	U-CHANNEL FOR RETURN PANEL / PROFILÉ EN «U» POUR PANNEAU DE RETOUR	1
11	VINYL-NH-S-86	WALL JAMB GASKET / JOINT DU JAMBAGE	2
12		RETURN PANEL / PANNEAU DE RETOUR	1
13	NH/S-BRACKET-XX	WALL MOUNT BRACKET / SUPPORT MURAL	1
14	MAGNET-NH-D-8-RP-86	FLAT MAGNETIC SIDE DOOR GASKET / JOINT LATÉRAL MAGNÉTIQUE PLAT DE LA PORTE	1
	MAGNET-NH-D-8-RP-86-33		
15		ROLLER (see chart below) / ROULETTE (voir le tableau ci-dessous)	1
16	NH/S-ANTIJUMP-XX	ANTI-JUMP / ANTI-SAUT	1
17	NH/S-HANDLE-XX	DOOR HANDLE / POIGNÉE DE PORTE	1
18	NH/S-BAR-ASSY-**-XX	RUNNING RAIL / BARRE DE ROULEMENT	1
19		GLASS FASTENER (see chart below) / FIXATION DE VERRE (voir le tableau ci-dessous)	2
ITEM	HARDWARE LISTING / LISTE DE QUINCAILLERIE		QTY
20		WALL PLUG / CHEVILLE	8
21		PAN HEAD SCREW / VIS À TÊTE CYLINDRIQUE	6
22		PAN HEAD SCREW / VIS À TÊTE CYLINDRIQUE	2
23		FLAT HEAD SELF-TAPPING SCREW / VIS AUTO TARAUDAGE À TÊTE PLATE	4
24		FLAT HEAD SELF-TAPPING SCREW / VIS AUTO TARAUDAGE À TÊTE PLATE	2
25		FASTENER CAPS / CAPUCHON DE FIXATION	2
26		ROLLER CAPS / CAPUCHON DE ROULETTE	2
27		CORNER ANCHOR CAP / CAPUCHON D'ANCRAGE DU COIN	1
28		CLEAR SETTING BLOCK (4 X 1/32" & 4 X 1/8") / BLOC À NIVEAU TRANSPARENT (4 X 1/32" & 4 X 1/8")	8
29		HEX KEY / CLÉ HEXAGONALE	2
30		INTERIOR WALL MOUNT BRACKET GASKET / JOINT INTÉRIEUR DU SUPPORT MURAL	1
31		EXTERIOR WALL MOUNT BRACKET GASKET / JOINT EXTÉRIEUR DU SUPPORT MURAL	1
32		WALL MOUNT BRACKET FOR RETURN PANEL / SUPPORT MURAL POUR PANNEAU DE RETOUR	1
33	NH/S-WJAMBCAP-XX	WALLJAMB CAP / CAPUCHON DU JAMBAGE	2

15 ROLLER OPTIONS / SÉLECTION DES ROULETTE

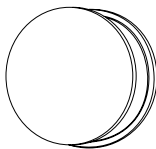
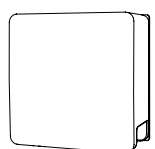
A	B
	
NH-ROLLER-XX	NS-ROLLER-XX

19 FASTENER OPTIONS / SÉLECTION DES FIXATION

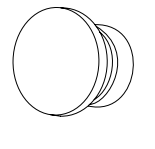
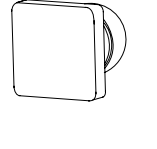
C	D
	
NH-FASTENER-XX	NS-FASTENER-XX

LEGEND / LÉGENDE
 XX = FINISH/FINI (11, 25, 33)
 ** = LENGTH / LONGUEUR (54, 60, 79, 86 ETC)
 ++ = CODE / CODE (AC, ABN)