

TOOLS REQUIRED / OUTILS REQUIS

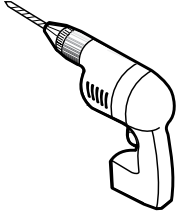

DRILL
PERCEUSE

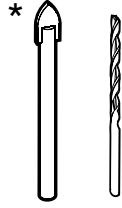

1/4" & 1/8" DRILL BITS
MÈCHE 1/4" & 1/8"

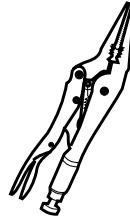

LONG NOSE LOCKING PLIERS (X4)
PINCE SERRE ÉTAU (X4)



SCREWDRIVER
TOURNEVIS



PENCIL
CRAYON

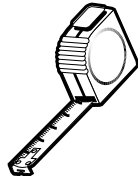

TAPE MEASURE
RUBAN À MESURER

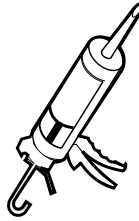

SILICONE
SCCELLANT

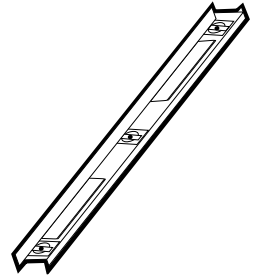

LEVEL
NIVEAU

* Use a 1/4" drill bit for ceramic when drilling into ceramic tiles
* Utiliser une mèche de 1/4" destiné à céramique lors du perçage des tuiles en céramique.

POSSIBLE CONFIGURATIONS / CONFIGURATIONS POSSIBLES

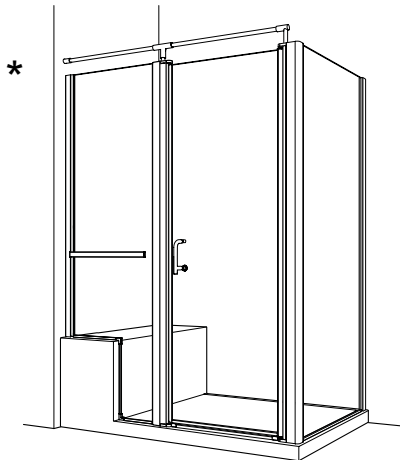

* This configuration is illustrated in this manual.
* Cette configuration est illustrée dans ce manuel.

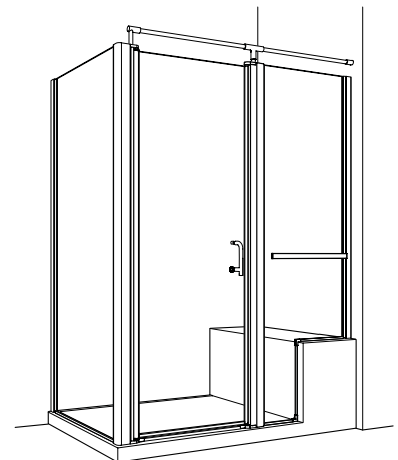
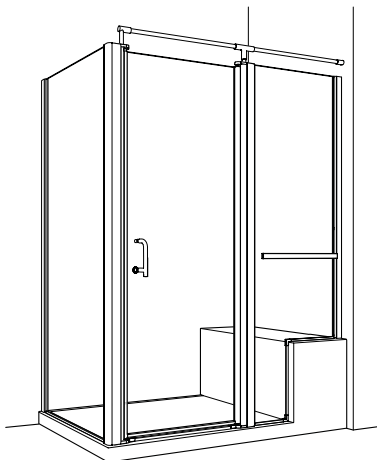
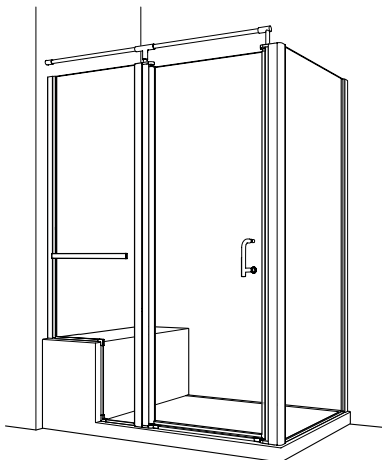

PARTS LISTING / LISTE DES PIÈCES

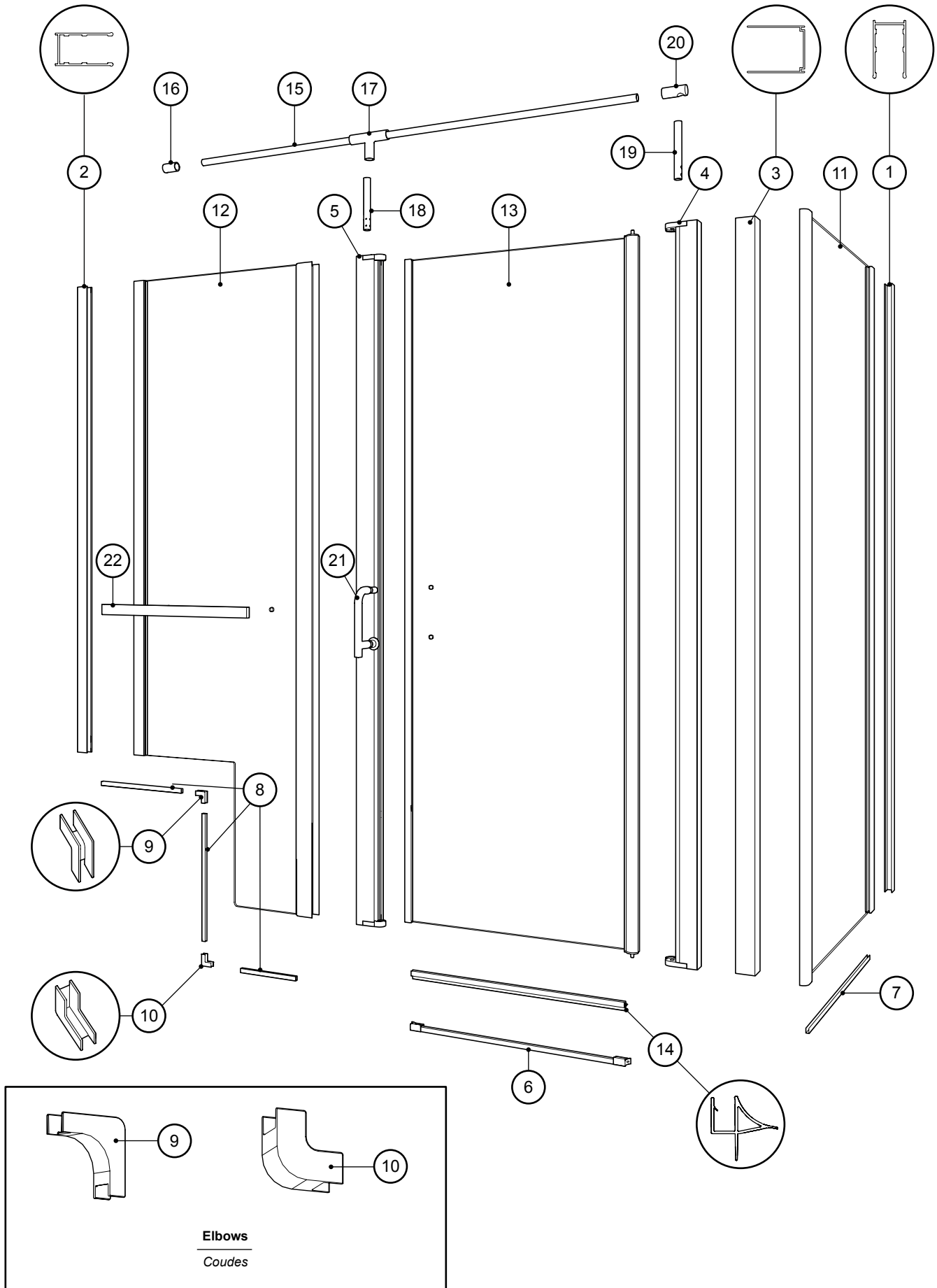

PARTS LISTING / LISTE DES PIÈCES

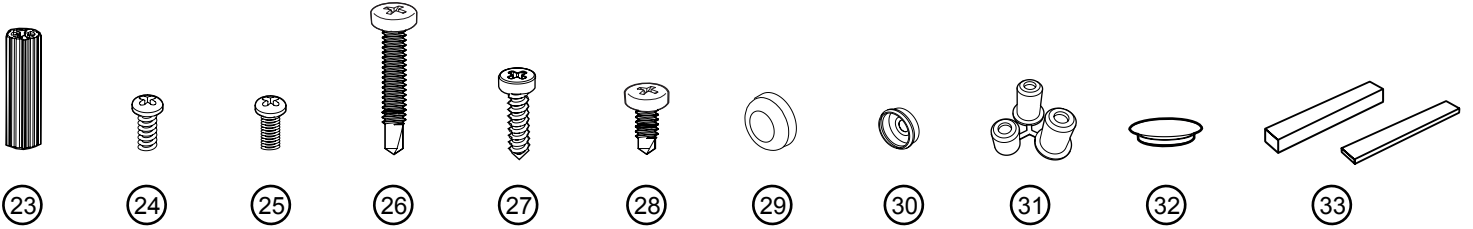

ITEM	PARTS AND HARDWARE / PIÈCES ET QUINCAILLERIE	QTY
1	WALL JAMB FOR RETURN PANEL (LONGER) / JAMBAGE POUR LE PANNEAU DE RETOUR (LONG)	1
2	WALL JAMB FOR FIXED PANEL (SHORTER) / JAMBAGE POUR LE PANNEAU FIXE (COURT)	1
3	CORNER JAMB / JAMBAGE DU COIN	1
4	PIVOT EXPANDER / EXTENSEUR À PIVOT	1
5	MAGNETIC EXPANDER / EXTENSEUR MAGNÉTIQUE	1
6	THRESHOLD / SEUIL	1
7	U-CHANNEL FOR RETURN PANEL / PROFILÉ EN "U" POUR LE PANNEAU DE RETOUR	1
8	U-CHANNEL FOR FIXED PANEL (SHORT, MEDIUM, LONG) / PROFILÉ EN "U" POUR LE PANNEAU FIXE (COURT, MI-LONG, LONG)	3
9	TOP ELBOW / COUDE SUPÉRIEUR	1
10	BOTTOM ELBOW / COUDE INFÉRIEUR	1
11	RETURN PANEL / PANNEAU DE RETOUR	1
12	FIXED PANEL / PANNEAU FIXE	1
13	DOOR PANEL / PANNEAU DE PORTE	1
14	BOTTOM DOOR GASKET / JOINT INFÉRIEUR DE LA PORTE	1
15	HORIZONTAL SUPPORT BAR / BARRE DE SUPPORT HORIZONTALE	1
16	WALL MOUNT BRACKET / SUPPORT MURAL	1
17	"T" CONNECTOR / CONNECTEUR "T"	1
18	VERTICAL MID SUPPORT BAR (SHORTER) / BARRE DE SUPPORT VERTICALE DU MILIEU (COURT)	1
19	VERTICAL END SUPPORT BAR (LONGER) / BARRE DE SUPPORT VERTICALE D'EXTRÉMITÉ (LONG)	1
20	END CONNECTOR / CONNECTEUR D'EXTRÉMITÉ	1
21	DOOR HANDLE / POIGNÉE DE LA PORTE	1
22	TOWEL BAR / BARRE À SERVIETTE	1
23	WALL PLUG / CHEVILLE	8
24	SUPPORT BAR SCREW (FOR MEDIUM HOLE) / VIS POUR LA BARRE DE SUPPORT (POUR TROU MEDIUM)	2
25	SUPPORT BAR SCREW (FOR SMALL HOLE) / VIS POUR LA BARRE DE SUPPORT (POUR PETIT TROU)	2
26	SELF-DRILLING WALL SCREW #8 - 1 1/4" / VIS MURAL AUTO-PERÇANTE #8 - 1 1/4"	8
27	ANCHORING SCREW / VIS D'ANCRAGE	1
28	SELF DRILLING PANHEAD SCREWS #8 - 3/8" / VIS À TÊTE PAN AUTO-PERÇANTE #8 - 3/8"	15
29	SCREW CAP / CAPUCHON COUVRE-VIS	12
30	BACK SCREW CAP / L'ARRIÈRE DU CAPUCHON COUVRE-VIS	12
31	PIVOT SLEEVE SET / ENSEMBLE MANCHON PIVOTANT	1
32	COVER / CAPUCHON	2
33	CLEAR SETTING BLOCKS / BLOCS À NIVEAU TRANSPARENTS	4