

TOOLS REQUIRED
OUTILS REQUIS

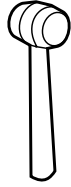

SAFETY GLASSES
LUNETTES DE SÉCURITÉ



MALLET
MAILLET



SCREWDRIVER
TOURNEVIS

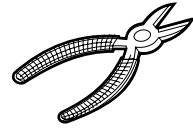

CUTTING PLIERS
PINCE COUPANTE

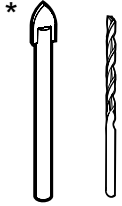

1/4" & 1/8" DRILL BITS
MÈCHE 1/4" & 1/8"

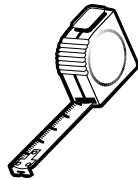

TAPE MEASURE
RUBAN À MESURER

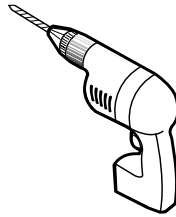

DRILL
PERCEUSE



PENCIL
CRAYON

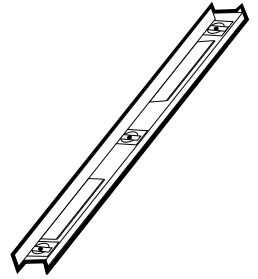

LEVEL
NIVEAU

*** Use a 1/4" drill bit for ceramic when drilling into ceramic tiles**

*** Utiliser une mèche de 1/4" destiné à céramique lors du perçage des tuiles en céramique.**

POSSIBLE CONFIGURATIONS
CONFIGURATIONS POSSIBLES

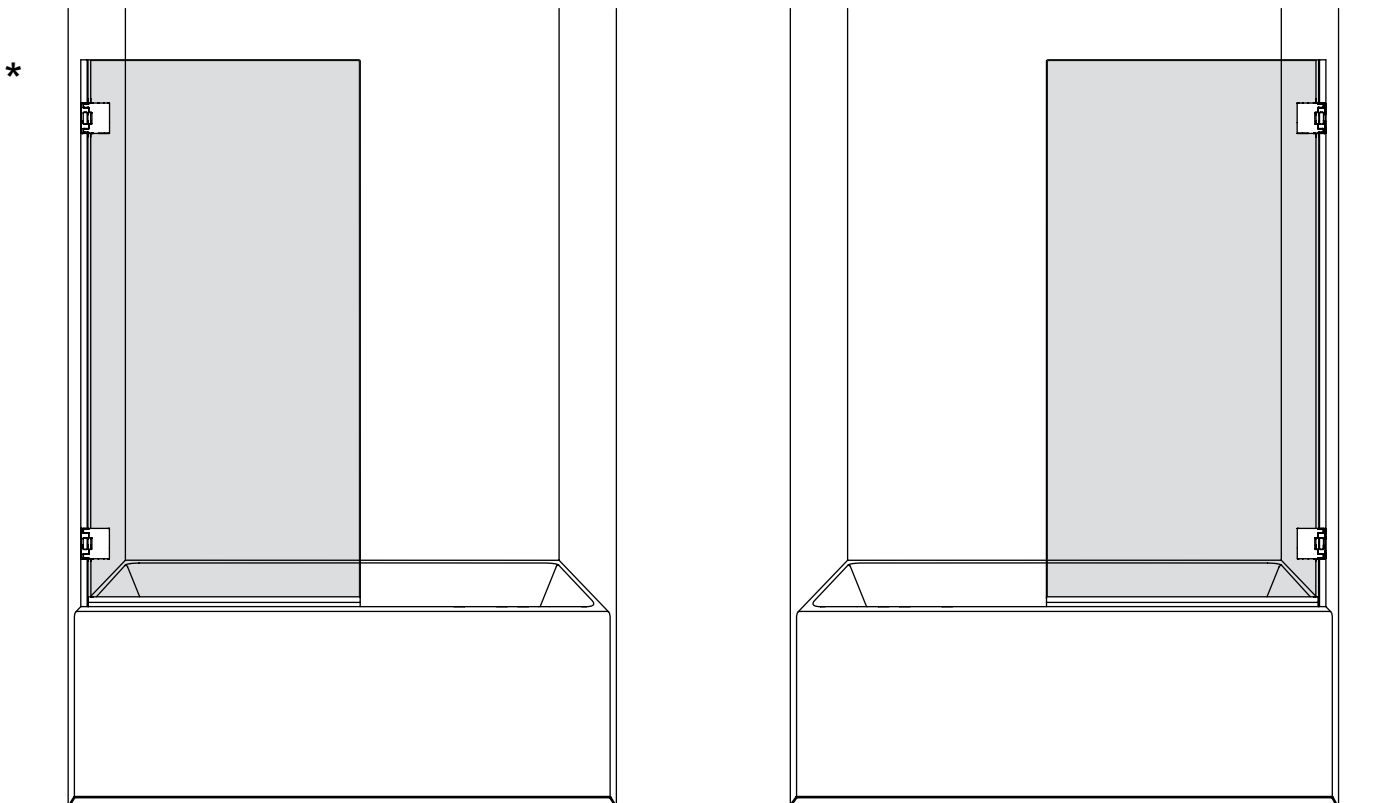

*** This configuration is illustrated in this manual.**

*** Cette configuration est illustrée dans ce manuel.**

PARTS AND HARDWARE LISTING
LISTE DES PIÈCES ET QUINCAILLERIE

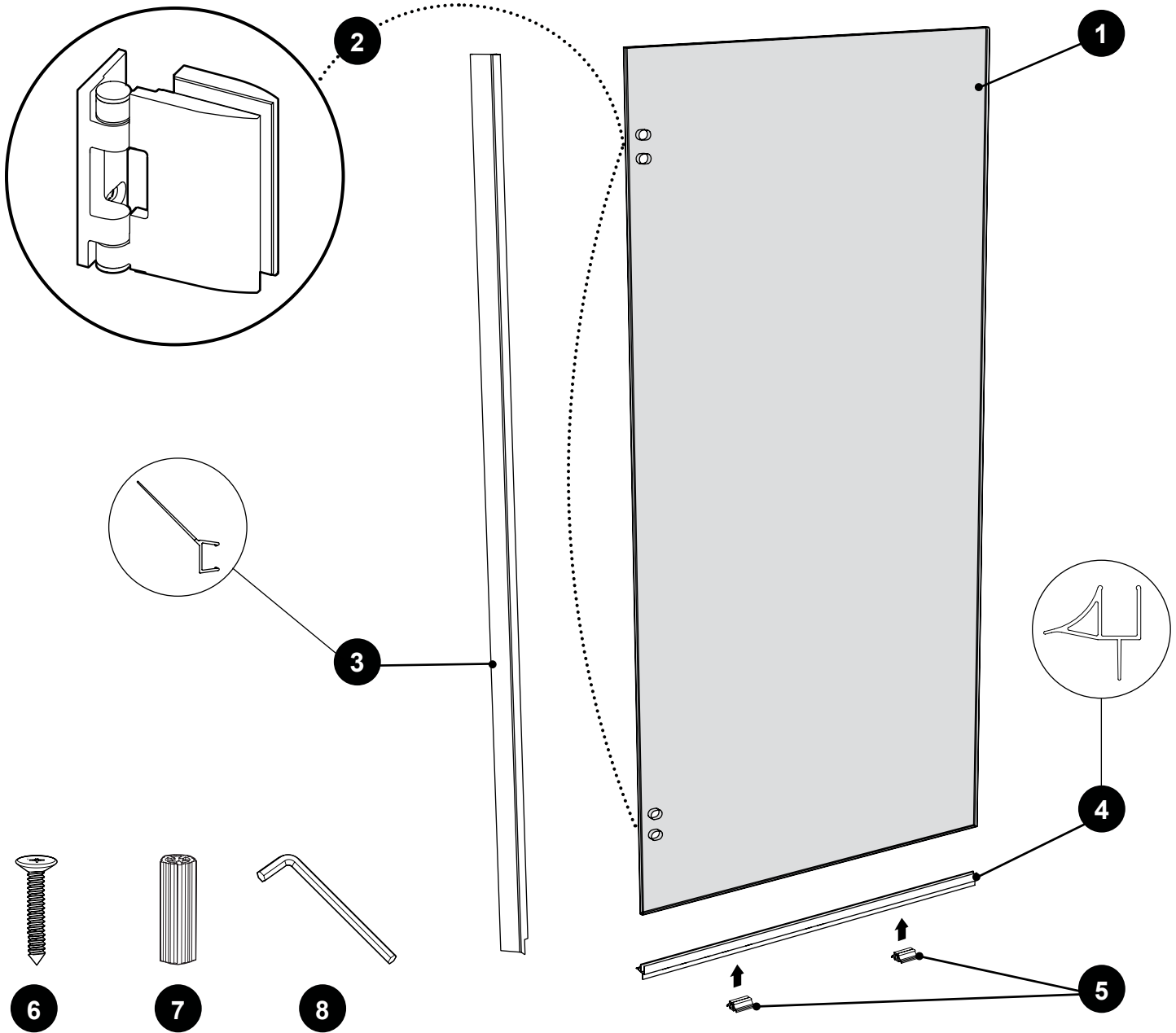

ITEM	PARTS LISTING / LISTE DES PIÈCES	QTY
1	DOOR PANEL / PANNEAU DE PORTE	1
2	WALL MOUNT HINGE / CHARNIÈRE	2
3	SIDE PANNEL GASKET / JOINT DE CÔTÉ	1
4	BOTTOM PANEL GASKET / JOINT INFÉRIEUR	1
5	LEVELING BLOCKS / BLOCS NIVELEURS	2
ITEM	HARDWARE LISTING / LISTE DE QUINCAILLERIE	QTY
6	PAN SELF-DRILLING SCREW # 8- 1-1/4" / VIS PAN AUTO-PERÇANTE # 8- 1-1/4"	4
7	WALL PLUG / CHEVILLE	4
8	ALLEN KEY / CLÉ ALLEN	1