

INSTALLATION MANUAL - GUIDE D'INSTALLATION

LA03

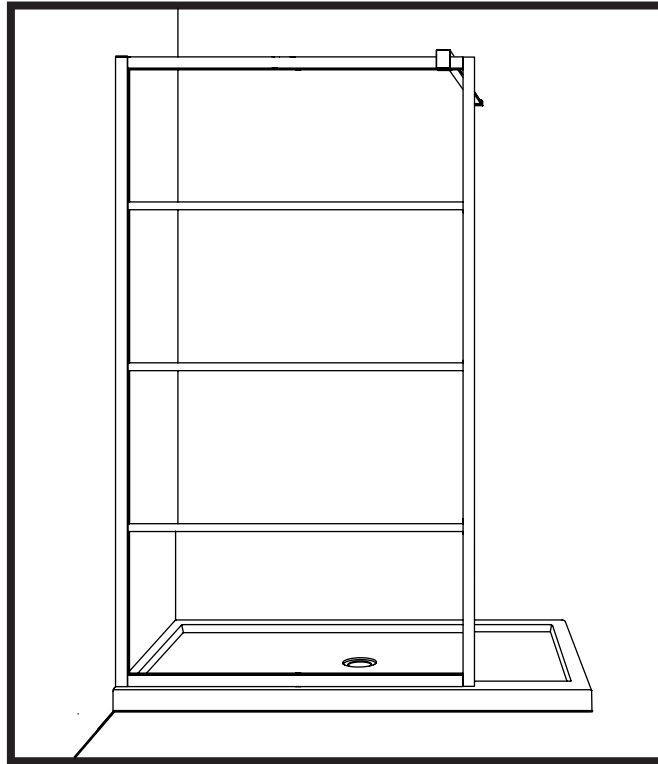

SHOWER / DOUCHE

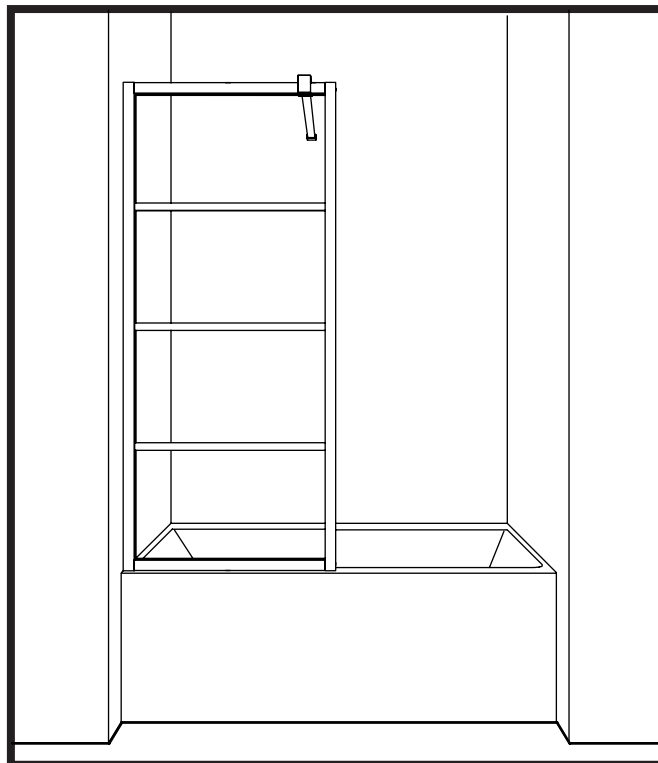

TUB / BAIGNOIRE

**TOOLS REQUIRED
OUTILS REQUIS**

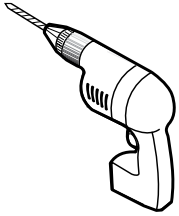

DRILL
PERCEUSE



1/4" & 1/8" DRILL BITS
MÈCHE 1/4" & 1/8"

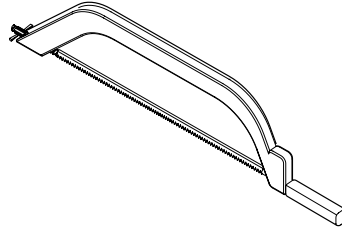

HACKSAW
SCIE À MÉTAUX

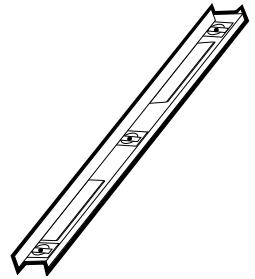

LEVEL
NIVEAU



PENCIL
CRAYON

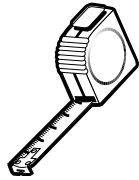

TAPE MEASURE
RUBAN À MESURER



SCREWDRIVER
TOURNEVIS

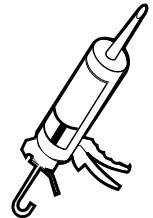

SILICONE
SCELLANT

*** Use a 1/4" drill bit for ceramic when drilling into ceramic tiles**
*** Utiliser une mèche à céramique de 1/4" lors du perçage des tuiles en céramique.**

**POSSIBLE CONFIGURATIONS
CONFIGURATIONS POSSIBLES**

*** SHOWER / DOUCHE**

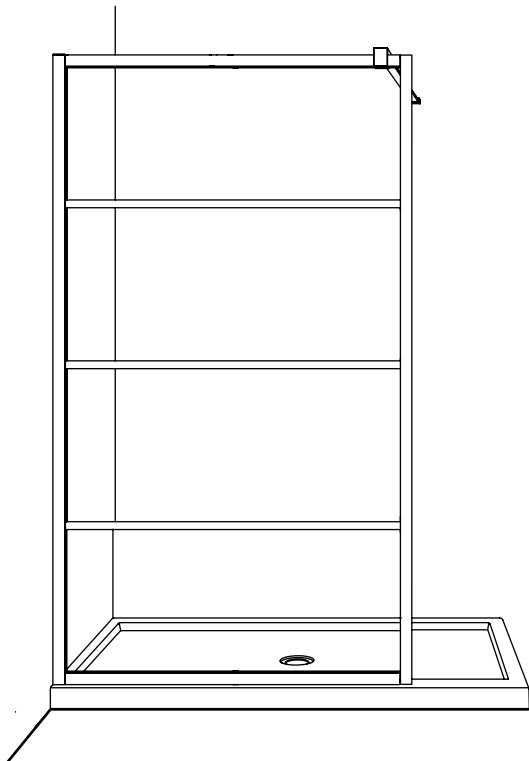

TUB / BAIGNOIRE

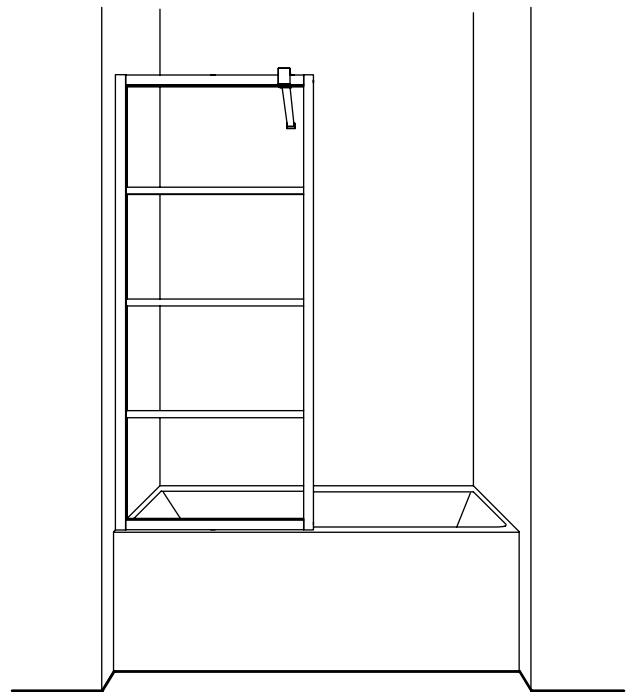

*** This configuration is illustrated in this manual.**
*** Cette configuration est illustrée dans ce manuel.**

PARTS AND HARDWARE LISTING
LISTE DES PIÈCES ET QUINCAILLERIE

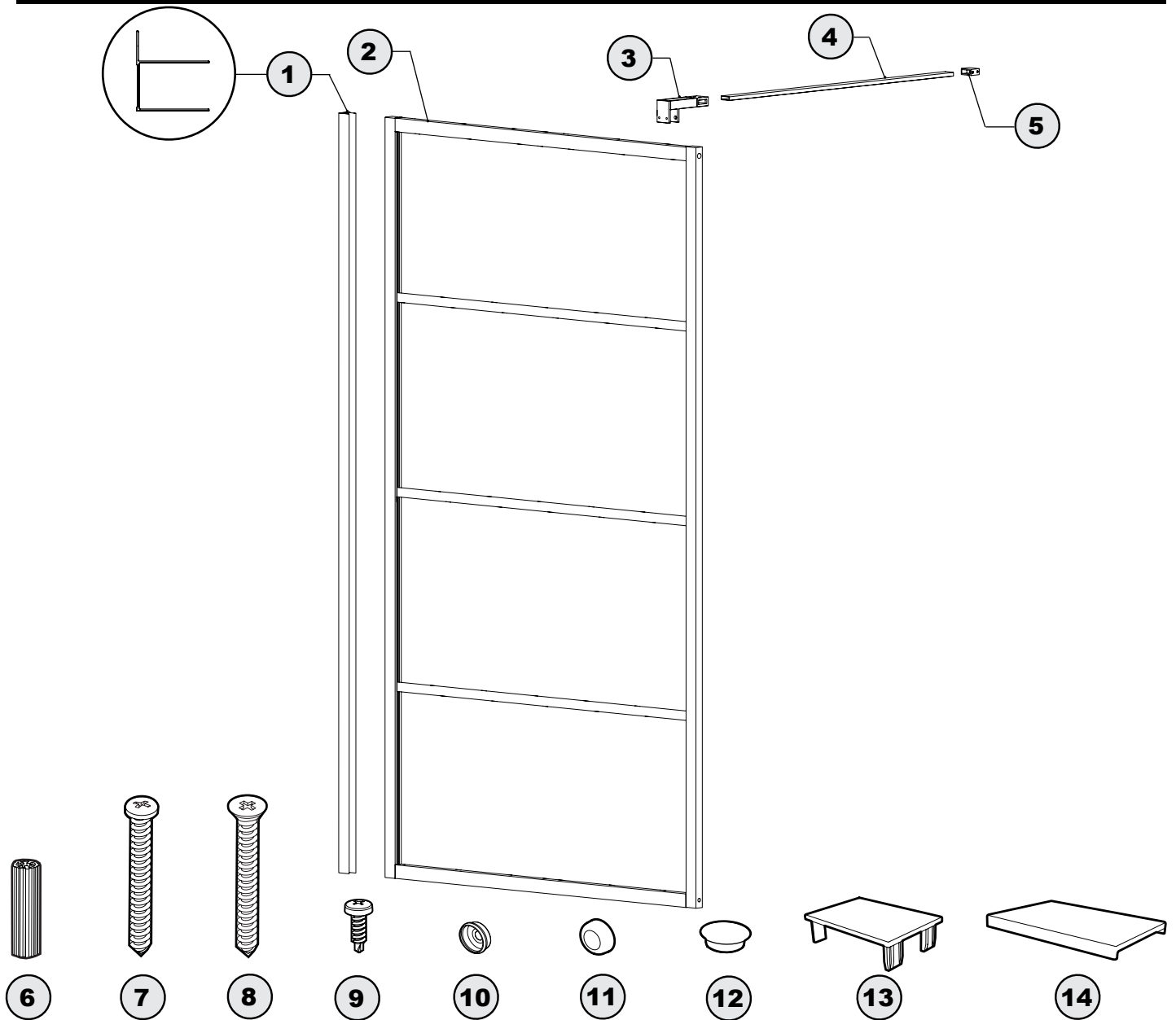

ITEM	PARTS AND HARDWARE / PIÈCES ET QUINCAILLERIE	QTY
1	WALL JAMB / JAMBAGE	2
2	FIXED PANEL / PANNEAU FIXE	1
3	GLASS MOUNT BRACKET / SUPPORT DE VERRE	1
4	SUPPORT BAR / BARRE DE SUPPORT	1
5	WALL MOUNT BRACKET / SUPPORT MURAL	1
6	WALL PLUG / CHEVILLE	4
7	FLAT HEAD SCREW / VIS À TÊTE PLATE	1
8	PAN HEAD SCREW / VIS À TÊTE CYLINDRIQUE	3
9	PAN SELF-DRILLING SCREW / VIS PAN AUTO-PERÇANTE	3
10	BACK SCREW CAP / L'ARRIÈRE DU CAPUCHON COUVRE-VIS	6
11	SCREW CAP / CAPUCHON COUVRE-VIS	6
12	SCREW CAP / CAPUCHON COUVRE-VIS	2
13	FRAME CAP / CAPUCHON DU CADRE	1
14	WALL JAMB CAP / CAPUCHON DU JAMBAGE	1

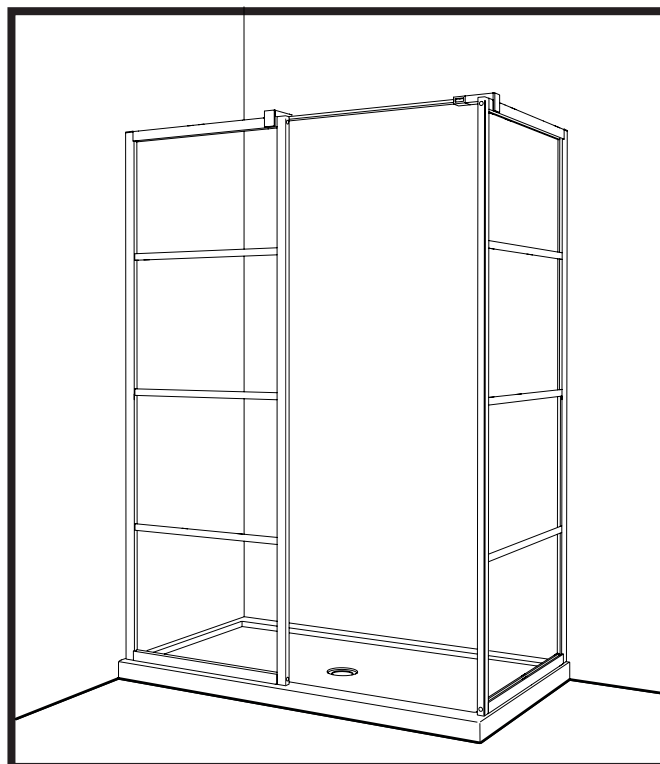

Shower enclosure / Porte de douche

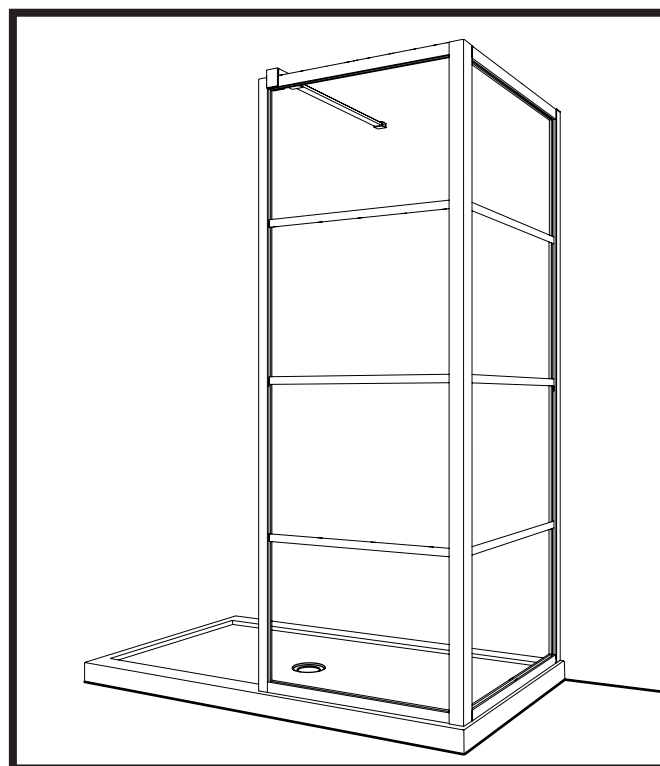

Shower enclosure / Porte de douche

TOOLS REQUIRED
OUTILS REQUIS

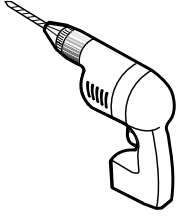

DRILL
PERCEUSE



1/4" & 1/8" DRILL BITS
MÈCHE 1/4" & 1/8"

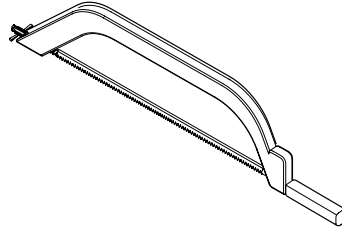

HACKSAW
SCIE À MÉTAUX

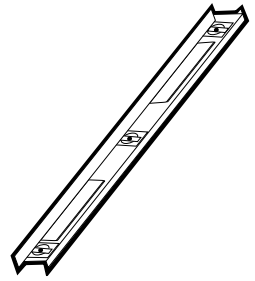

LEVEL
NIVEAU



PENCIL
CRAYON

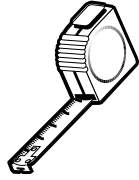

TAPE MEASURE
RUBAN À MESURER



SCREWDRIVER
TOURNEVIS

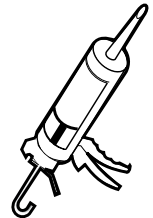

SILICONE
SCELLANT

*** Use a 1/4" drill bit for ceramic when drilling into ceramic tiles**
*** Utiliser une mèche à céramique de 1/4" lors du perçage des tuiles en céramique.**

POSSIBLE CONFIGURATIONS
CONFIGURATIONS POSSIBLES

SHOWER / DOUCHE

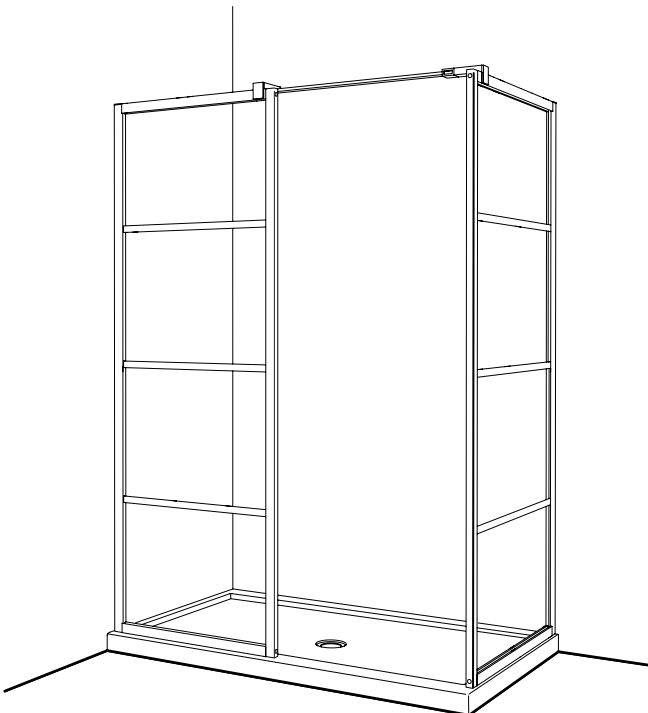

SHOWER / DOUCHE

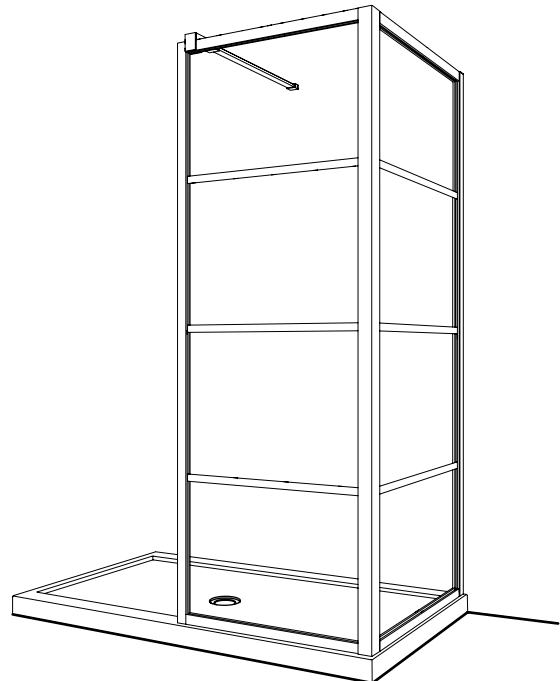

PARTS AND HARDWARE LISTING
LISTE DES PIÈCES ET QUINCAILLERIE

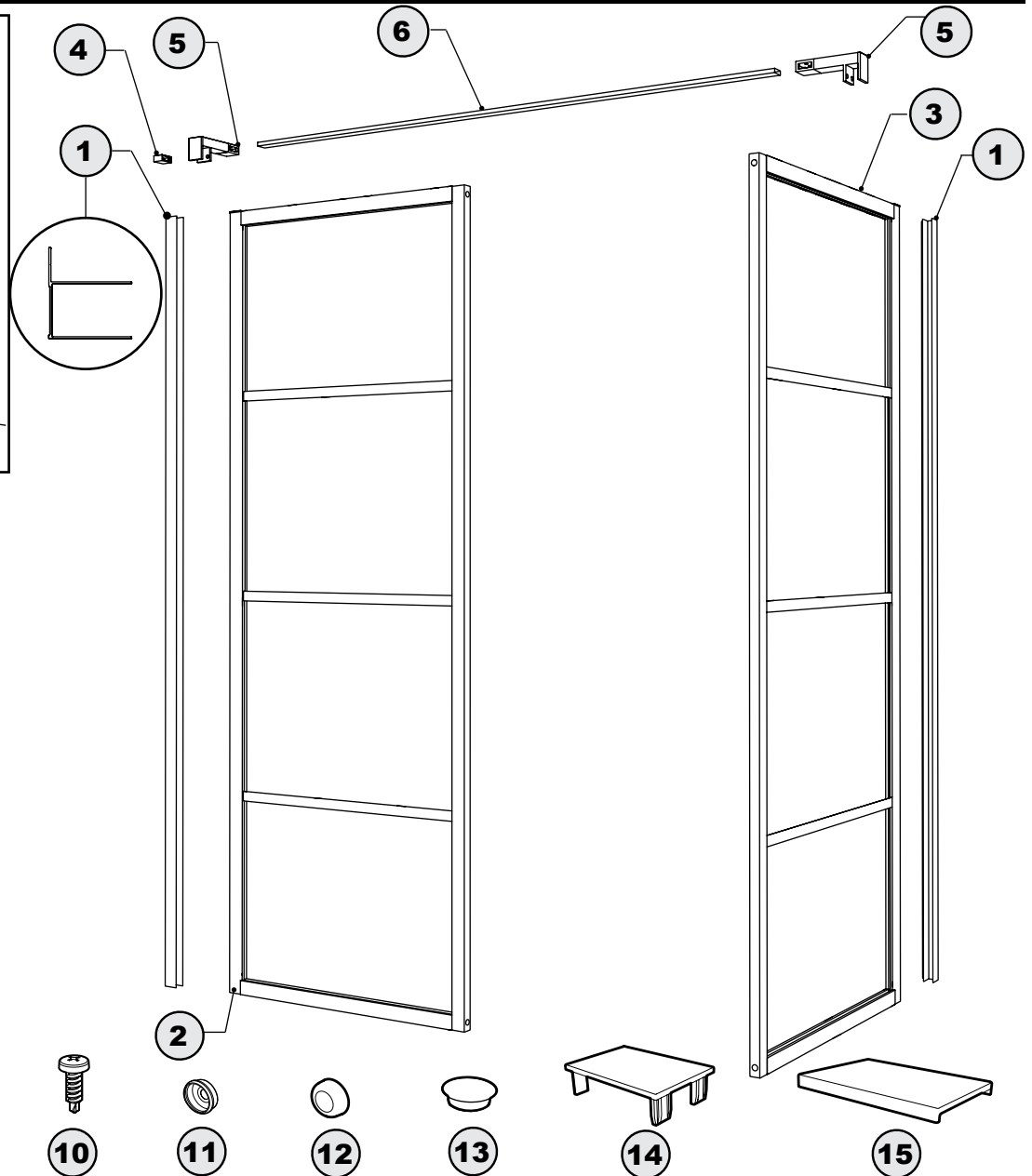
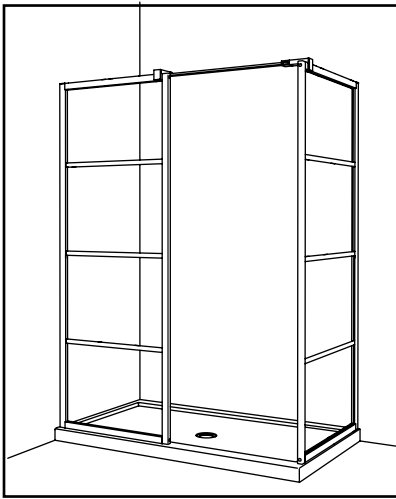

ITEM	PARTS AND HARDWARE / PIÈCES ET QUINCAILLERIE	QTY
1	WALL JAMB / JAMBAGE	2
2	FIXED PANEL / PANNEAU FIXE	1
3	RETURN PANEL / PANNEAU DE RETOUR	1
4	WALL MOUNT BRACKET / SUPPORT MURAL	1
5	GLASS MOUNT BRACKET / SUPPORT DE VERRE	2
6	SUPPORT BAR / BARRE DE SUPPORT	1
7	WALL PLUG / CHEVILLE	7
8	PAN HEAD SCREW / VIS À TÊTE CYLINDRIQUE	6
9	FLAT HEAD SCREW / VIS À TÊTE PLATE	1
10	PAN SELF-DRILLING SCREW / VIS PAN AUTO-PERÇANTE	6
11	BACK SCREW CAP / CAPUCHON COUVRE-VIS ARRIERE	6
12	SCREW CAP / CAPUCHON COUVRE-VIS	6
13	SCREW CAP / CAPUCHON COUVRE-VIS	4
14	FRAME CAP / CAPUCHON DU CADRE	4
15	WALL JAMB CAP / CAPUCHON DU JAMBAGE	2