

**TOOLS REQUIRED  
OUTILS REQUIS**

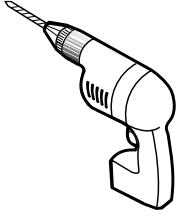

**DRILL**  
**PERCEUSE**



**1/4" & 1/8" DRILL BITS**  
**MÈCHE 1/4" & 1/8"**

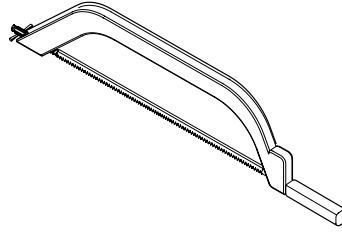

**HACKSAW**  
**SCIE À MÉTAUX**

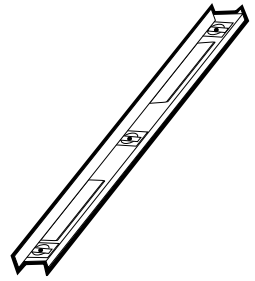

**LEVEL**  
**NIVEAU**



**PENCIL**  
**CRAYON**

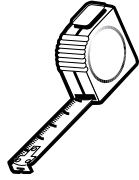

**TAPE MEASURE**  
**RUBAN À MESURER**



**SCREWDRIVER**  
**TOURNEVIS**

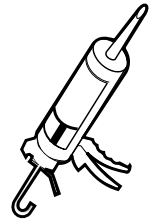

**SILICONE**  
**SCELLANT**

**\* Use a 1/4" drill bit for ceramic when drilling into ceramic tiles**  
**\* Utiliser une mèche de 1/4" destiné à céramique lors du perçage des tuiles en céramique.**

**POSSIBLE CONFIGURATIONS  
CONFIGURATIONS POSSIBLES**

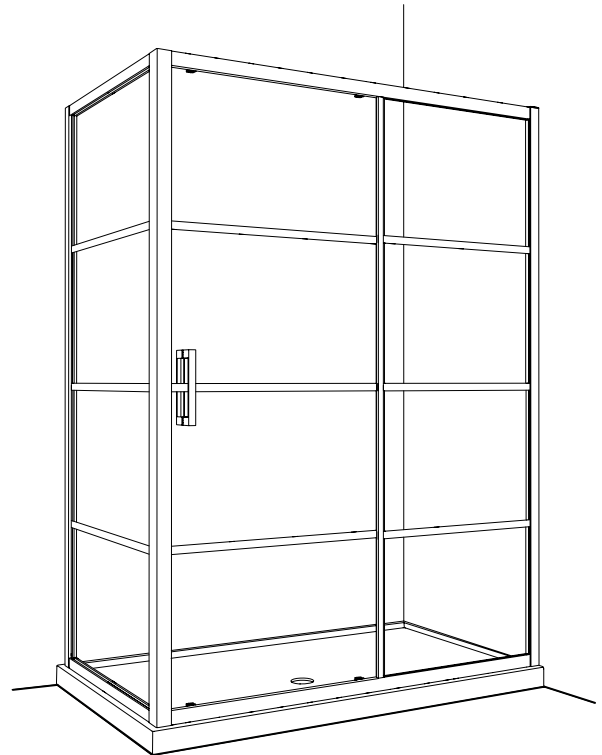
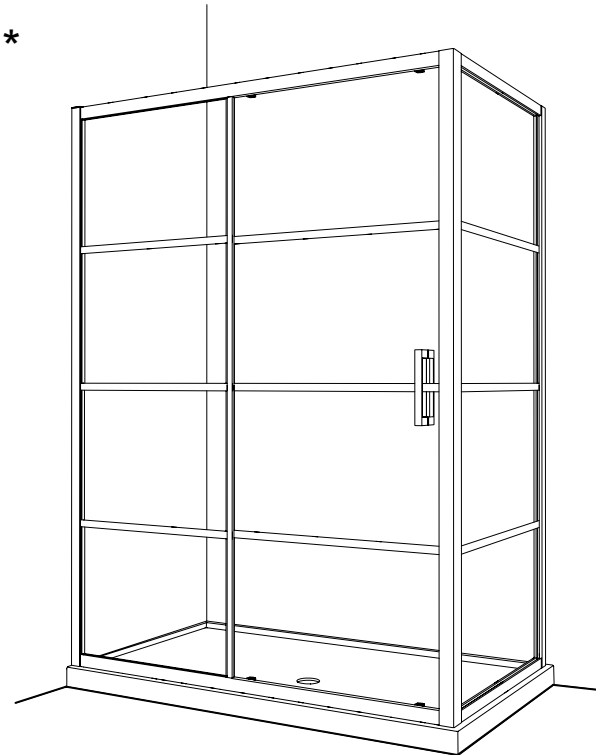

**\* This configuration illustrated in this manual.**  
**\* Cette configuration est illustrée dans ce manuel.**

**PARTS AND HARDWARE LISTING**  
**LISTE DES PIÈCES ET QUINCAILLERIE**

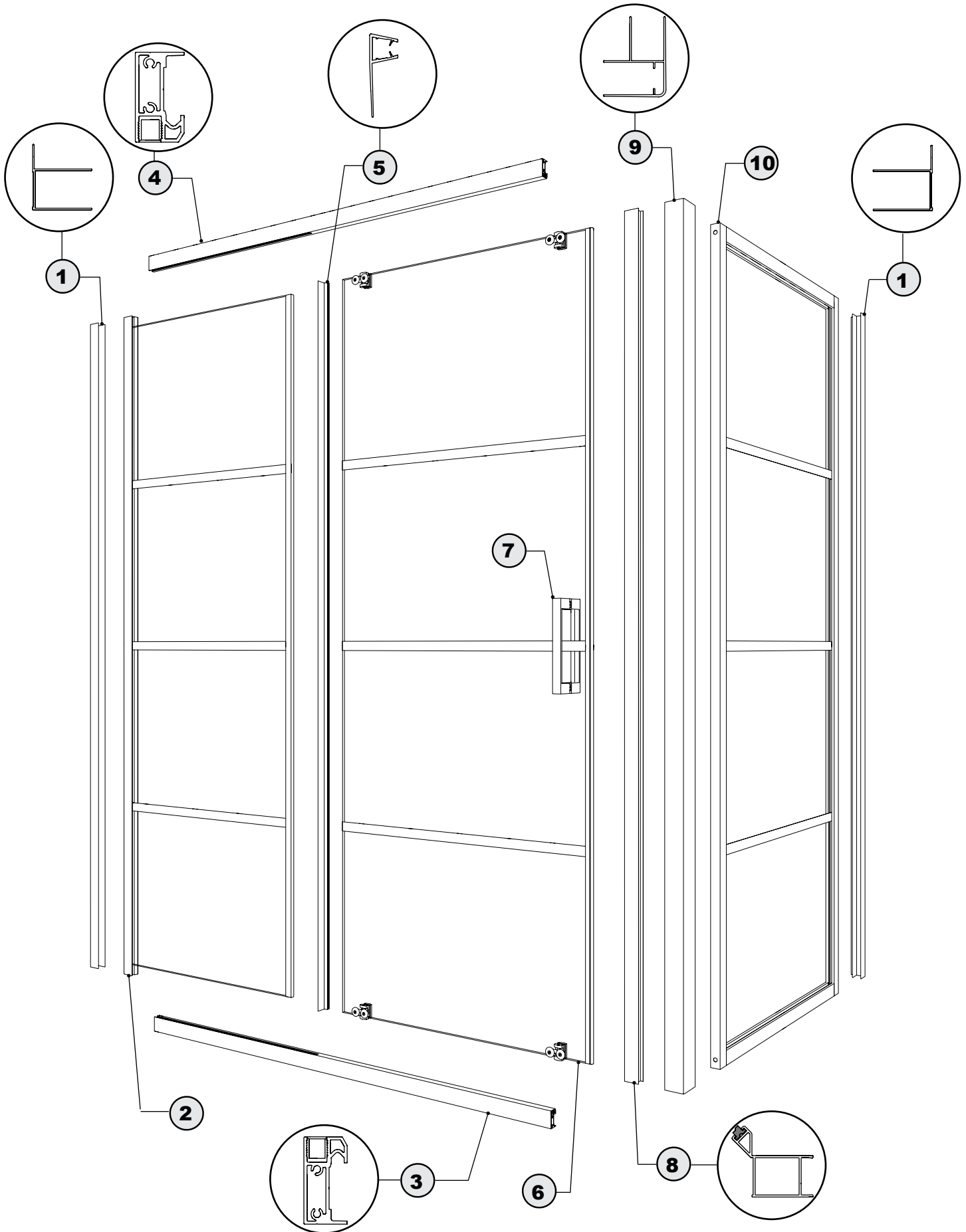

**PARTS LISTING / LISTE DES PIÈCES**

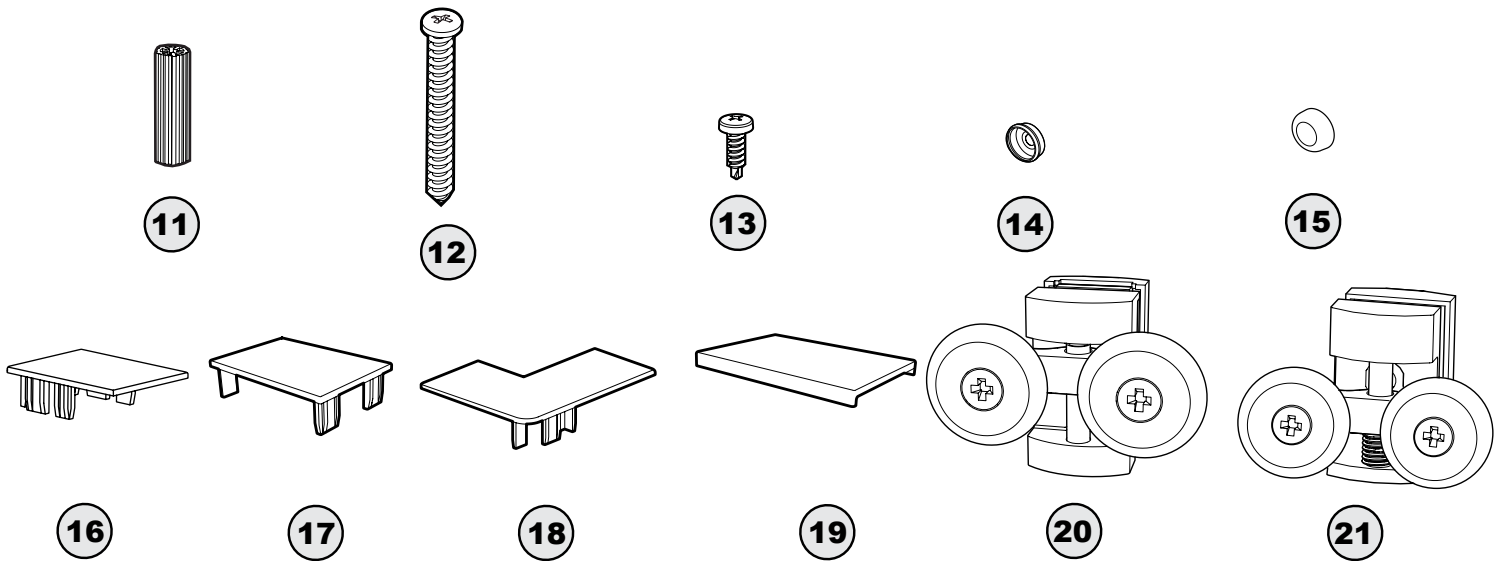

ITEM	PARTS AND HARDWARE / PIÈCES ET QUINCAILLERIE	QTY
1	WALL JAMB / JAMBAGE	2
2	FIXED PANEL / PANNEAU FIXE	1
3	BOTTOM TRACK / RAIL DU BAS	1
4	TOP TRACK / RAIL DU HAUT	1
5	SIDE GASKET / JOINT LATÉRAL DE LA PORTE	1
6	DOOR PANEL / PANNEAU DE PORTE	1
7	HANDLE / POIGNÉE	1
8	MAGNETIC EXPANDER / EXTENSEUR MAGNÉTIQUE	1
9	CORNER JAMB / JAMBAGE DU COIN	1
10	RETURN PANEL / PANNEAU DE RETOUR	1
11	WALL PLUG / CHEVILLE	6
12	PAN HEAD SCREW / VIS À TÊTE CYLINDRIQUE	14
13	PAN SELF-DRILLING SCREW / VIS PAN AUTO-PERÇANTE	12
14	BACK SCREW CAP / CAPUCHON COUVRE-VIS ARRIERE	18
15	SCREW CAP / CAPUCHON COUVRE-VIS	18
16	FRAME CAP FOR FIXED PANEL SIDE / CAPUCHON DU CADRE POUR DE CÔTÉ DU PANNEAU FIXE	1
17	FRAME CAP FOR RETURN PANEL SIDE / CAPUCHON DU CADRE POUR DE CÔTÉ DU PANNEAU DE RETOUR	1
18	CORNER JAMB CAP / CAPUCHON DU JAMBAGE DU COIN	2
19	WALL JAMB CAP / CAPUCHON DU JAMBAGE	2
20	TOP WHEEL / ROULETTE DU HAUT	2
21	BOTTOM WHEEL / ROULETTE DU BAS	2