

TOOLS REQUIRED / OUTILS REQUIS

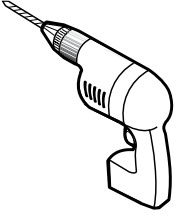

DRILL
PERCEUSE

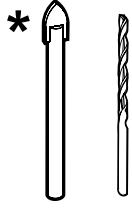

1/4" & 1/8" DRILL BITS
MÈCHE 1/4" & 1/8"



LOCKING PLIERS
PINCE SERRE



SCREWDRIVER
TOURNEVIS

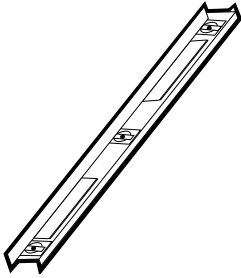

LEVEL
NIVEAU

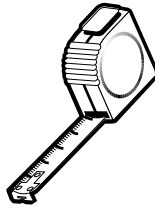

TAPE MEASURE
RUBAN À MESURER

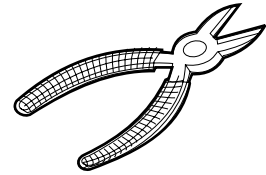

CUTTING PLIER
PINCE COUPANTE



PENCIL
CRAYON



SAFETY GLASSES
LUNETTES DE SÉCURITÉ

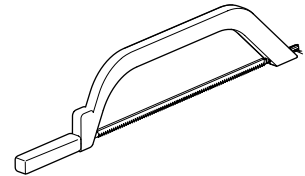

HACKSAW
SCIE À MÉTAUX

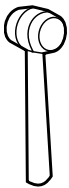

MALLET
MAILLET



BLOCK
BLOC

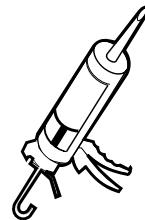

SILICONE
SCELLANT

*** Use a 1/4" drill bit for ceramic when drilling into ceramic tiles**

*** Utiliser une mèche de 1/4" destiné à céramique lors du perçage des tuiles en céramique.**

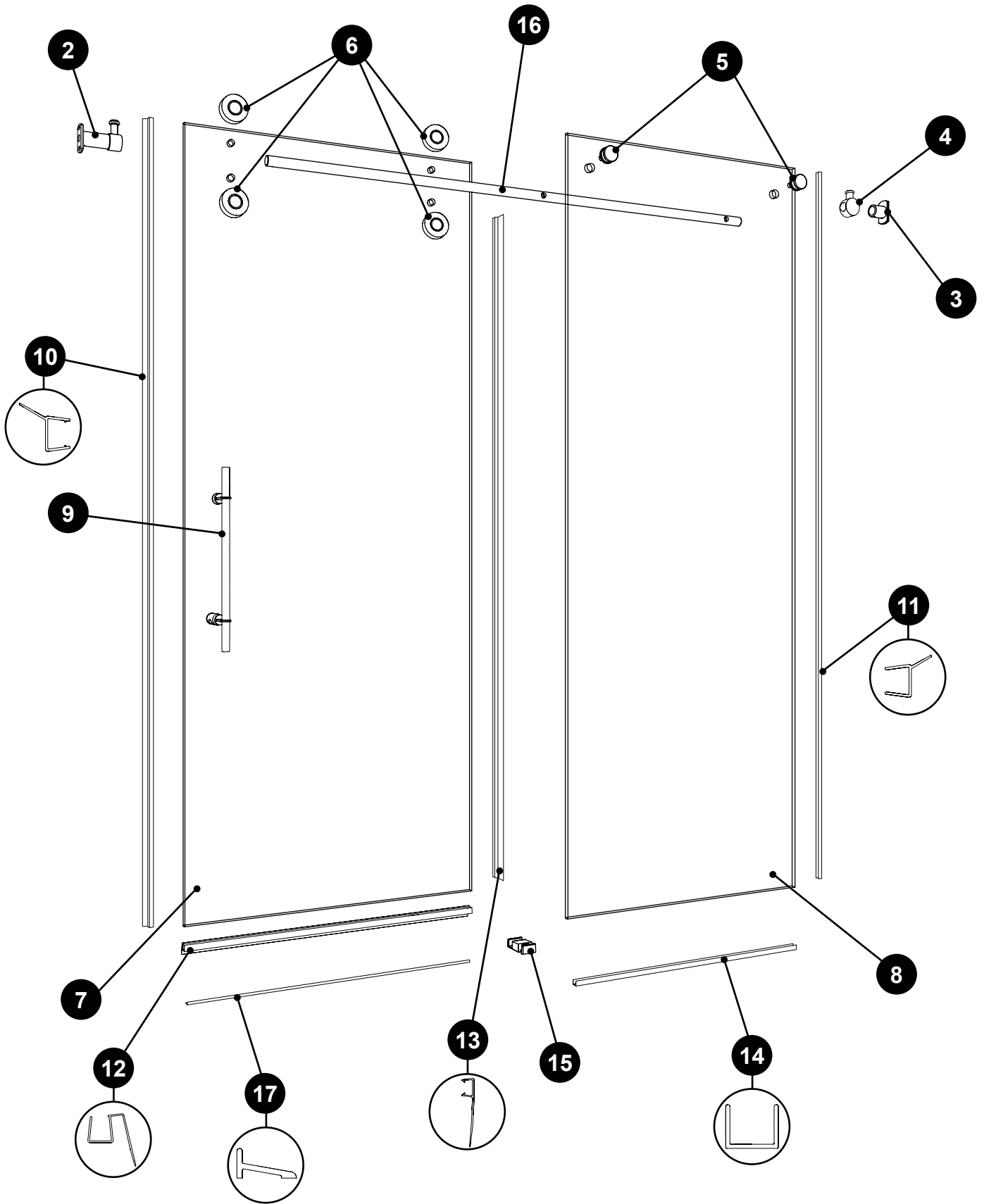

PARTS AND HARDWARE LISTING / LISTE DES PIÈCES ET QUINCAILLERIE

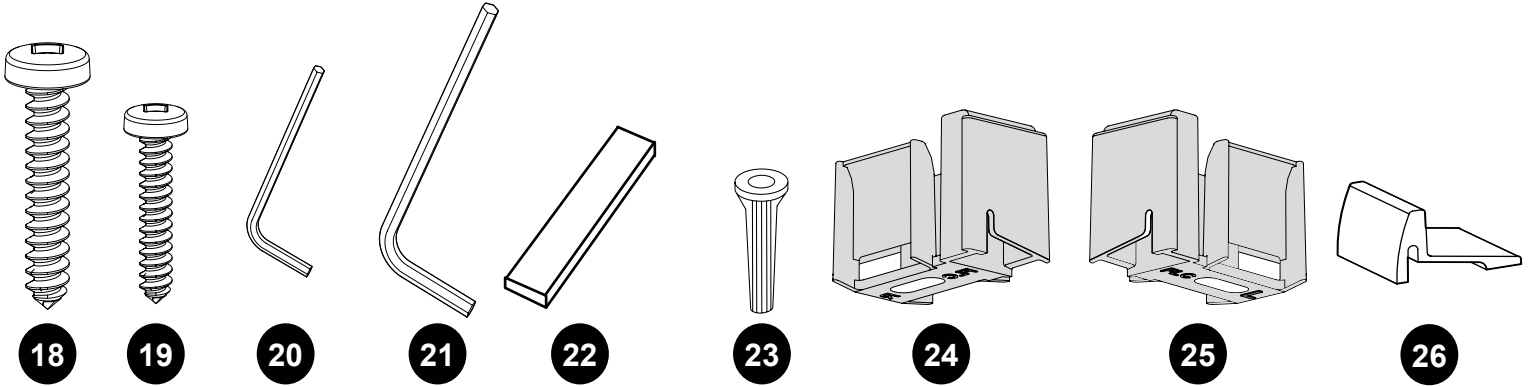

ITEM	PARTS AND HARDWARE / PIÈCES ET QUINCAILLERIE	QTY
1	RUNNING RAIL / BARRE DE ROULEMENT	1
2	WALL BRACKET WITH STOPPER / SUPPORTS MURAL AVEC BUTOIR	1
3	WALL BRACKET / SUPPORTS MURAL	1
4	STOPPER / BUTOIR	1
5	GLASS FASTENER / SUPPORT DE VERRE	2
6	ROLLER / ROULETTE	2 SET / PAIRS
7	DOOR PANEL / PANNEAU DE PORTE	1
8	FIXED PANEL / PANNEAU FIXE	1
9	HANDLE / POIGNÉE	1
10	DOOR PANEL GASKET / JOINT DE RÉTENTION POUR LA PORTE	1
11	FIXED PANEL GASKET / JOINT DE RÉTENTION POUR LA PORTE	1
12	DOOR BOTTOM SWEEP / JOINT INFÉRIEUR	1
13	CENTER GASKET / JOINT DU CENTRE	1
14	U-CHANNEL / PROFILE EN «U»	1
15	CENTER GUIDE / GUIDE DU CENTRE	1
16	RUNNING RAIL / BARRE DE ROULEMENT	1
17	THRESHOLD / SEUIL	1
18	#12-3 VIS AUTO-PERCANTE / #12-3 SELF-THREADING SCREW	4
19	#6-1 VIS AUTO-PERCANTE / #6-1 SELF-THREADING SCREW	2
20	HEX KEY 3mm	1
21	HEX KEY 6mm (7/32")	1
22	CLEAR SETTING BLOCK / BLOC NIVEAU TRANSPARENT	4
23	WALL PLUGS / CHEVILLES	2
24	PART B / PIÈCE B	1
25	PART A / PIÈCE A	1
26	THRESHOLD ANCHOR / ANCRAGE DU SEUIL	1