

TOOLS REQUIRED / OUTILS REQUIS

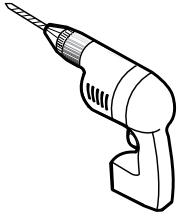

DRILL
PERCEUSE

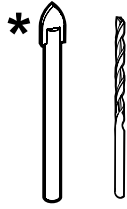

1/4" & 1/8" DRILL BITS
MÈCHES 1/4" & 1/8"



LOCKING PLIERS
PINCES SERRE



SCREWDRIVER
TOURNEVIS

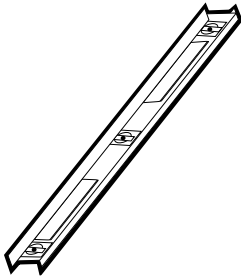

LEVEL
NIVEAU

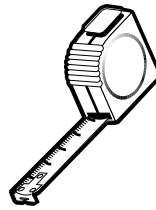

TAPE MEASURE
RUBAN À MESURER

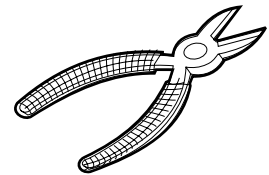

CUTTING PLIER
PINCE COUPANTE

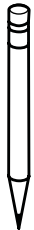

PENCIL
CRAYON



SAFETY GLASSES
LUNETTES DE SÉCURITÉ

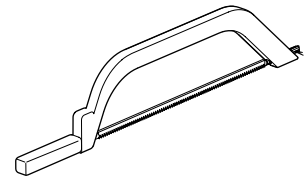

HACKSAW WITH BI METAL BLADE
SCIE À MÉTAUX LAME BI-MÉTAL

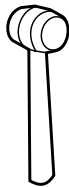

MALLET
MAILLET

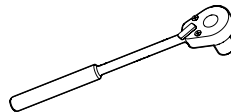

RATCHET
CLÉ À ROCHET

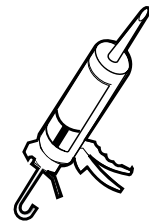

SILICONE
SCCELLANT

* Use a 1/4" drill bit for ceramic when drilling into ceramic tiles

* Utiliser une mèche de 1/4" destiné à céramique lors du perçage des tuiles en céramique.

PARTS LISTING / LISTE DES PIÈCES

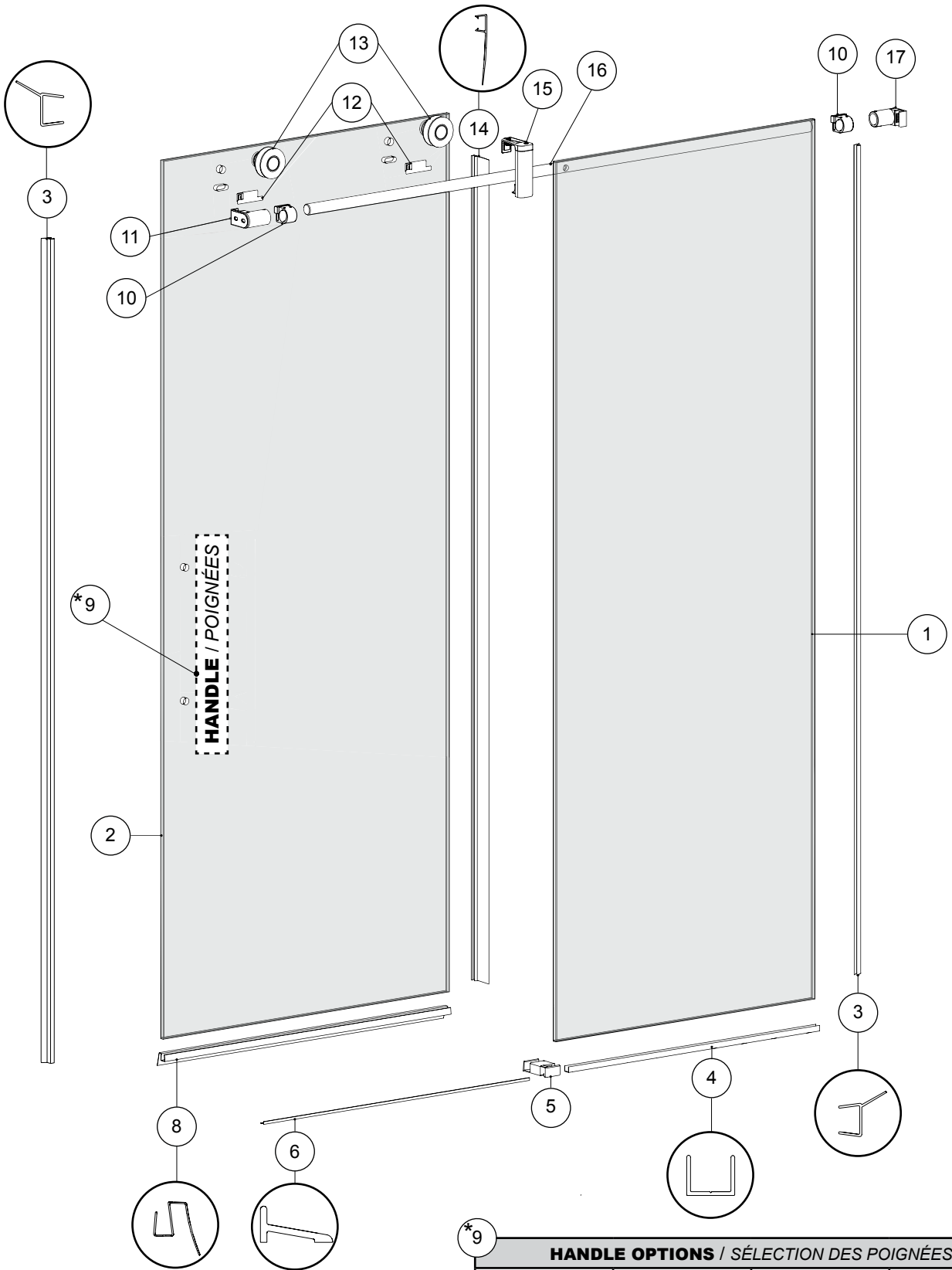

***9**

HANDLE OPTIONS / SÉLECTION DES POIGNÉES

A	B	C	D

PARTS LISTING / LISTE DES PIÈCES

ITEM	PARTS LISTING / LISTE DES PIÈCES	QTY
1	FIXED PANEL / PANNEAU FIXE	1
2	DOOR PANEL / PANNEAU DE PORTE	1
3	SIDE GASKET / JOINT LATÉRAL	1
4	U-CHANNEL / PROFILÉ EN «U»	1
5	BOTTOM GUIDE / GUIDE INFÉRIEUR	1
6	THRESHOLD / SEUIL	1
7	THRESHOLD ANCHOR / ANCRAGE DU SEUIL	1
8	BOTTOM GASKET / JOINT INFÉRIEUR	1
9	HANDLE / POIGNÉE	1
10	STOPPER / BUTOIR	2
11	WALL BRACKET / SUPPORT MURAL	1
12	ANTI-JUMP / ANTI-SAUT	2
13	ROLLER / ROULETTE	2
14	SIDE DOOR GASKET / JOINT LATÉRAL DE LA PORTE	1
15	TOP GUIDE CAP / CAPUCHON DU GUIDE	1
16	RUNNING RAIL / BARRE DE ROULEMENT	1
17	WALL BRACKET / SUPPORT MURAL	1
ITEM	HARDWARE LISTING / LISTE DE QUINCAILLERIE	QTY
18	WALL PLUG / CHEVILLE	4
19	CLEAR SETTING BLOCK (1/16") / BLOC À NIVEAU TRANSPARENT (1/16")	2
20	CLEAR SETTING BLOCK (1/8") / BLOC À NIVEAU TRANSPARENT (1/8")	2
21	GUIDE BUMPER / BUTOIR DU GUIDE	1
22	PLASTIC PART (A) / PIÈCE EN PLASTIQUE (A)	1
23	PLASTIC PART (B) / PIÈCE EN PLASTIQUE (B)	1
24	ANTI-JUMP SHIM / CALE POUR L'ANTI-SAUT	2
25	FLAT HEAD SCREW #10 (2 1/2") / VIS À TÊTE PLATE # 10 (2 1/2")	4
26	FLAT SELF-DRILLING SCREW #6 (1") / VIS PLATE AUTO-PERÇANTE # 6 (1")	1
27	FLAT HEAD SCREW #8 (1/2") / VIS À TÊTE PLATE # 8 (1/2")	1
28	SOCKET HEAD SCREW M5(12MM) / VIS ALLEN M5 (12MM)	1
29	SOCKET HEAD SCREW M8(20MM) / VIS ALLEN M8 (20MM)	1

HARDWARE LISTING / LISTE DE QUINCAILLERIE

