

TOOLS REQUIRED / OUTILS REQUIS

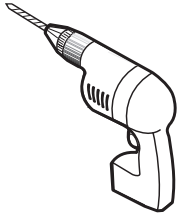

DRILL
PERCEUSE

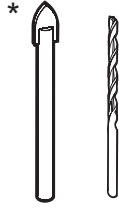

1/4" & 1/8" DRILL BITS
MÈCHES 1/4" & 1/8"



SCREWDRIVER
TOURNEVIS



SCREWDRIVER
TOURNEVIS



PENCIL
CRAYON



SUPER GLUE
COLLE FORTE

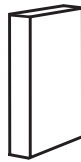

BLOCK
BLOC

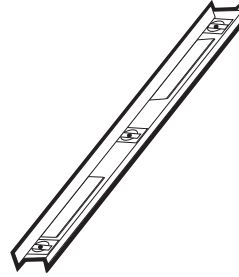

LEVEL
NIVEAU

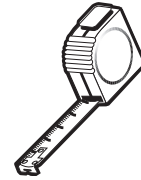

TAPE MEASURE
RUBAN À MESURER

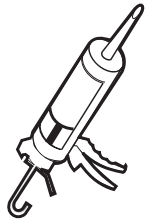

SILICONE
SCCELLANT

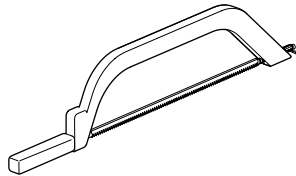

HACKSAW
SCIE À MÉTAUX

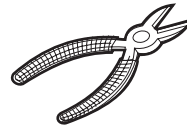

CUTTING PLIERS
PINCE COUPANTE



MALLET
MAILLET

* Use a 1/4" drill bit when drilling into ceramic tiles

* Utiliser une mèche de 1/4" pour percer des tuiles en céramique.

TOOLS REQUIRED TO CUT THE RUNNING RAIL OUTILS REQUIS POUR COUPER LA BARRE DE ROULEMENT

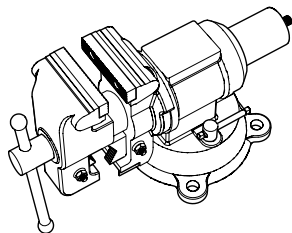
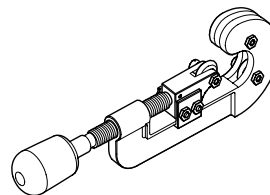

TABLE VISE
ÉTAU DE TABLE



**TUBE CUTTER WITH CUTTER WHEEL FOR STAINLESS
STEEL (TUBE DIAMETER : 1" / 25.4mm)**

COUPE-TUBE AVEC UNE ROUE COUPANTE POUR ACIER
INOXYDABLE (DIAMÈTRE DU TUBE: 1" / 25.4mm)

PARTS LISTING / LISTE DES PIÈCES

POSSIBLE CONFIGURATIONS / CONFIGURATIONS POSSIBLES

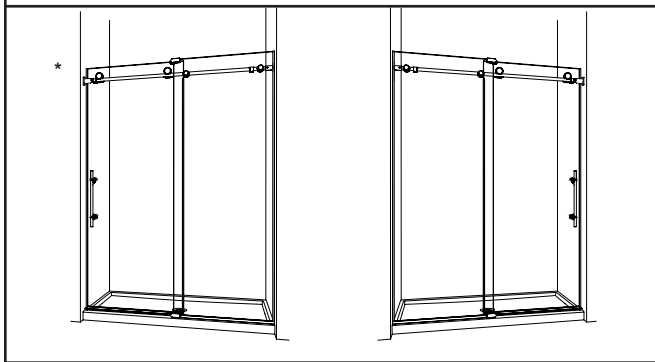

* This configuration illustrated in this manual.
 * Cette configuration est illustrée dans ce manuel.

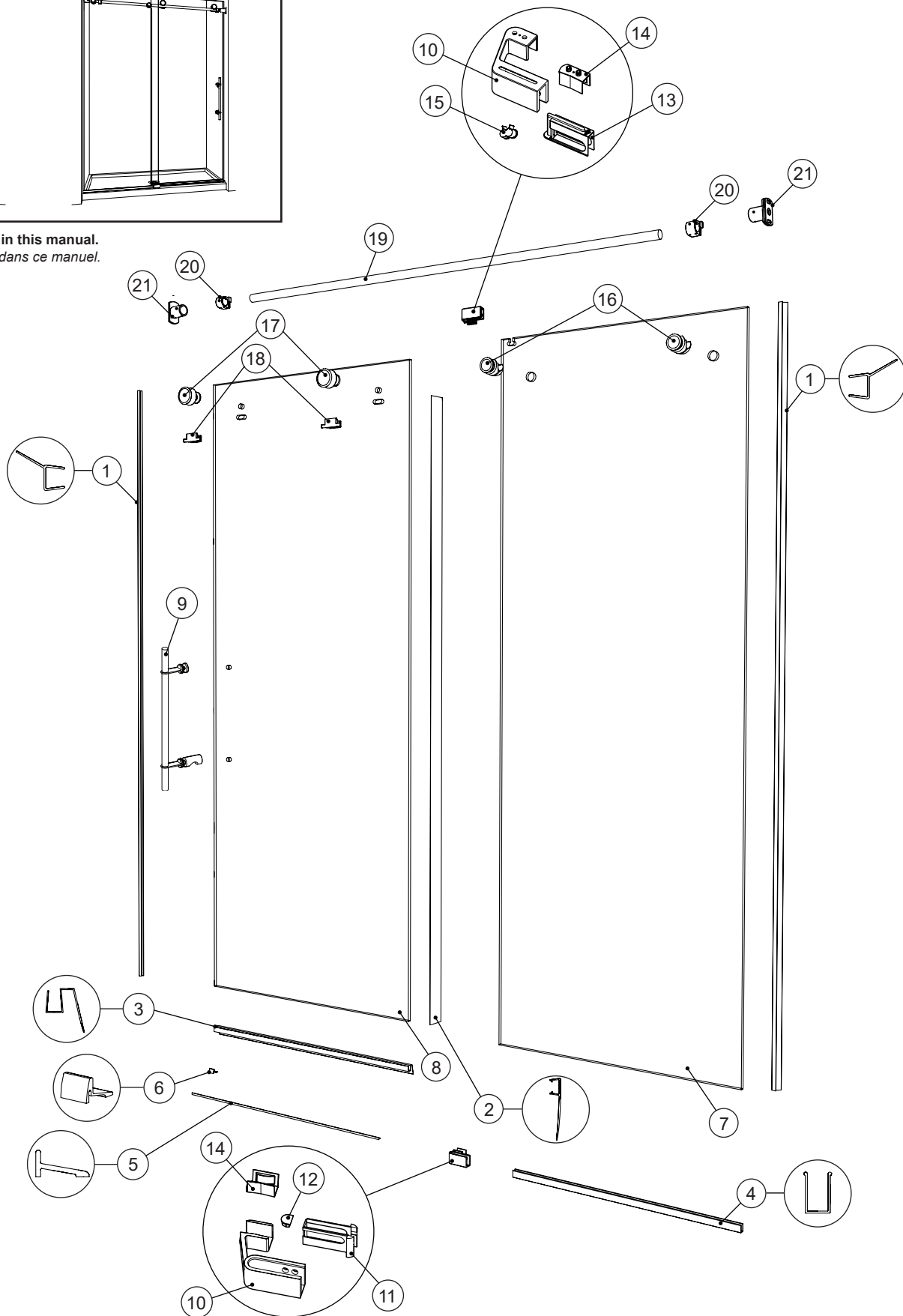

PARTS LISTING / LISTE DES PIÈCES

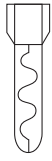

22



23

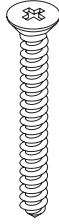

24

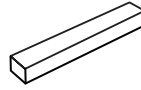

25

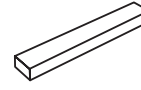

26

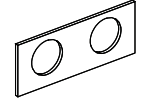

27

ITEM	FLEURCO CODE	PARTS AND HARDWARE / PIÈCES ET QUINCAILLERIE	QTY
1	COEX K120-80	SIDE GASKET / JOINT DE CÔTÉ	2
2	COEX K330-80	MID GASKET / JOINT LATÉRAL	1
3	COEX K130-72	BOTTOM DOOR GASKET / JOINT INFÉRIEUR DE LA PORTE	1
4	++15410-10-80	U-CHANNEL / PROFILÉ EN "U"	1
5	++15405	THRESHOLD / SEUIL	1
6	PENDCAP-XX	THRESHOLD ANCHOR / ANCRAGE DU SEUIL	1
7		FIXED PANEL / PANNEAU FIXE	1
8		DOOR PANEL / PANNEAU DE PORTE	1
9		HANDLE / POIGNÉE	1
10	K2GUIDESET-XX-R2	GUIDE / GUIDE	2
11		BOTTOM SLEEVE / GAINÉ PROTECTRICE INFÉRIEURE	1
12		GUIDE CAP / CAPUCHON DU GUIDE	1
13		TOP SLEEVE / GAINÉ PROTECTRICE SUPÉRIEURE	1
14		PLASTIC GUIDE / GUIDE EN PLASTIQUE	2
15		SCREW INSERT / INSERT DE VIS	1
16	K2FASTENER-XX	GLASS FASTENER / FIXATION DE VERRE	2
17	K2ROLLER-R1	ROLLER / ROULETTE	2
18	K2STRIKER-XX	ANTI-JUMP / ANTI-SAUT	2
19	K2BARXX-7260C	RUNNING RAIL / BARRE DE ROULEMENT	1
20	K2STOPPER-XX	STOPPER / BUTOIR	2
21	KTWBRACKET2-XX	WALL BRACKET / SUPPORT MURAL	2
22		WALL PLUG / CHEVILLE	4
23		FLAT SELF-DRILLING SCREW #6 (1") / VIS PLAT AUTO-PERÇANTE # 6 (1")	1
24		FLAT HEAD SCREW #10 (2 1/2") / VIS À TÊTE PLATE # 10 (2 1/2")	4
25		CLEAR SETTING BLOCK (5/32") / BLOC NIVEAU TRANSPARENT (5/32")	4
26		CLEAR SETTING BLOCK (1/8") / BLOC NIVEAU TRANSPARENT (1/8")	4
27		ANTI-JUMP SHIM / CALE POUR L'ANTI-SAUT	2

LEGEND / LÉGENDE
 XX = FINISH/FINI (11, 25, 33)
 ** = LENGTH / LONGUEUR (54, 60, 79, 86 ETC)
 ++ = CODE / CODE (AC, ABN)