

TOOLS REQUIRED / OUTILS REQUIS

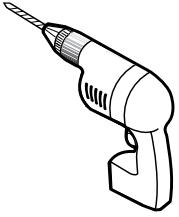

DRILL
PERCEUSE

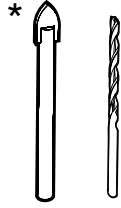

1/4" & 1/8" DRILL BITS
MÈCHE 1/4" & 1/8"



SCREWDRIVER
TOURNEVIS

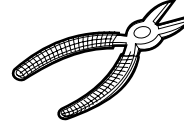

CUTTING PLIERS
PINCE COUPANTE

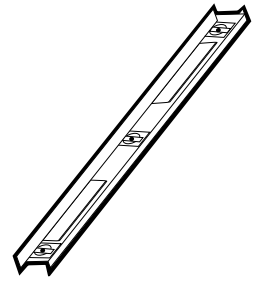

LEVEL
NIVEAU



PENCIL
CRAYON



TAPE MEASURE
RUBAN À MESURER



SAFETY GLASSES
LUNETTES DE SÉCURITÉ



MALLET
MAILLET

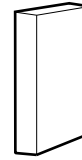

BLOCK
BLOC

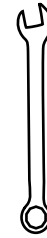

WRENCH
CLÉ À FOURCHE

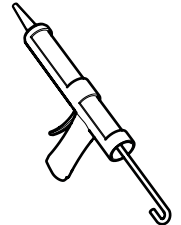

SILICONE
SCCELLANT

* Use a 1/4" drill bit for ceramic when drilling into ceramic tiles

* Utiliser une mèche de 1/4" destiné à céramique lors du perçage des tuiles en céramique.

POSSIBLE CONFIGURATIONS / CONFIGURATIONS POSSIBLES

SHOWER / DOUCHE

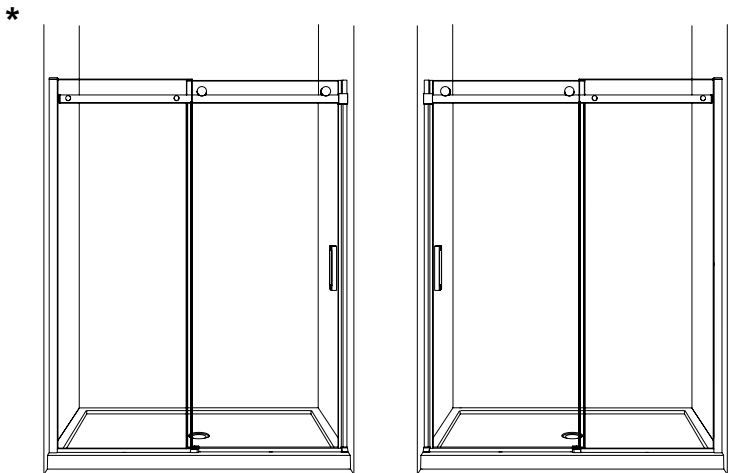

TUB / BAIGNOIRE

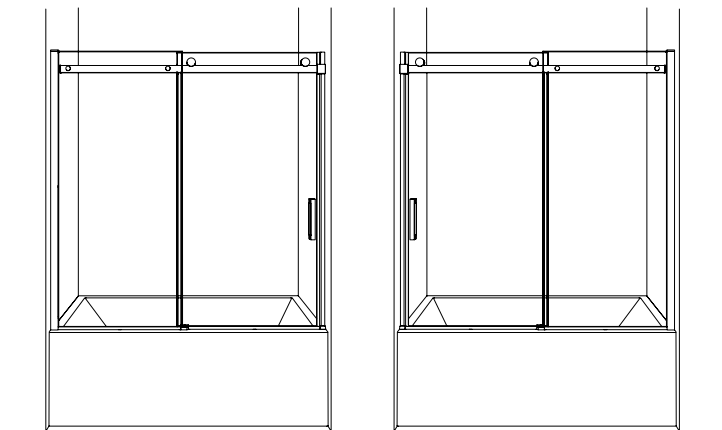







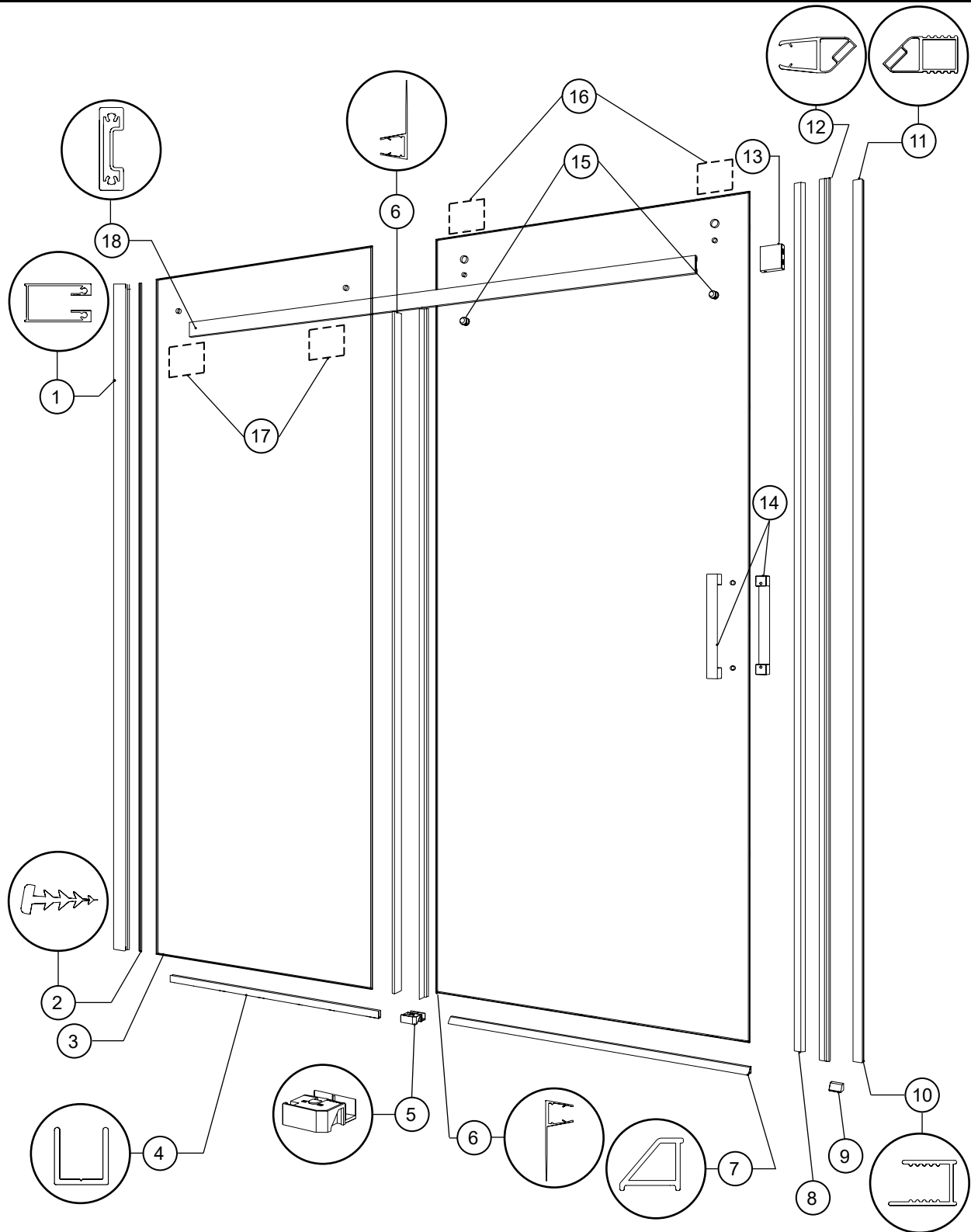

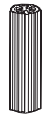
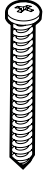

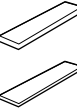

* THIS CONFIGURATION IS ILLUSTRATED IN THIS MANUAL. FOLLOW THE SAME STEPS FOR THE TUB.

* CETTE CONFIGURATION EST ILLUSTRÉE DANS CE MANUEL. SUIVRE LES MÊMES ÉTAPES POUR LA BAIGNOIRE.

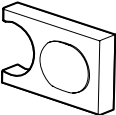
PARTS LISTING / LISTE DES PIÈCES



- 
 19
- 
 20
- 
 21
- 
 22
- 
 23
- 
 24
- 
 25
- 
 26
- 
 27
- 
 28
- 
 29
- 
 30
- 
 31
- 
 32

HARDWARE LISTING / LISTE DE QUINCAILLERIE

ITEM	PARTS LISTING / LISTE DES PIÈCES	QTY
1	WALLJAMB / JAMBAGE	1
2	WALL JAMB GASKET / JOINT DU JAMBAGE	1
3	FIXED PANEL / PANNEAU FIXE	1
4	U-CHANNEL FOR FIXED PANEL / PROFILÉ EN «U» POUR PANNEAU FIXE	1
5	BOTTOM GUIDE / GUIDE INFÉRIEUR	1
6	MID GASKET FOR DOOR PANEL AND FIXED PANEL / JOINT LATÉRAL POUR LE PANNEAU DE PORTE ET PANNEAU FIXE	2
7	THRESHOLD / SEUIL	1
8	DOOR PANEL / PANNEAU DE PORTE	1
9	THRESHOLD ANCHOR / L'ANCRAGE DE SEUIL	1
10	WALLJAMB FOR DOOR PANEL / JAMBAGE POUR LE PANNEAU DE PORTE	1
11	WALL JAMB GASKET FOR DOOR PANEL / JOINT DU JAMBAGE POUR LE PANNEAU DE PORTE	1
12	MAGNETIC SIDE DOOR GASKET / JOINT LATÉRAL MAGNÉTIQUE DE LA PORTE	1
13	WALL MOUNT BRACKET / SUPPORT MURAL	1
14	DOOR HANDLE / POIGNÉE DE PORTE	1
15	ANTI-JUMP / ANTI-SAUT	2
16	ROLLER (see chart below) / ROULETTE (voir le tableau ci-dessous)	2
17	GLASS FASTENER (see chart below) / FIXATION DE VERRE (voir le tableau ci-dessous)	2
18	RUNNING RAIL / BARRE DE ROULEMENT	1
ITEM	HARDWARE LISTING / LISTE DE QUINCAILLERIE	QTY
19	WALL PLUG / CHEVILLE	9
20	PAN HEAD SCREW / VIS À TÊTE CYLINDRIQUE	6
21	FLAT HEAD SELF-TAPPING SCREW / VIS AUTO TARAUDAGE À TÊTE PLATE	2
22	FLAT HEAD SELF-TAPPING SCREW / VIS AUTO TARAUDAGE À TÊTE PLATE	2
23	PAN HEAD SCREW / VIS À TÊTE CYLINDRIQUE	1
24	FASTENER CAPS / CAPUCHON DE FIXATION	2
25	ROLLER CAPS / CAPUCHON DE ROULETTE	2
26	CLEAR SETTING BLOCK (2 X 1/16" & 2 X 1/8") / BLOC À NIVEAU TRANSPARENT (2 X 1/16" & 2 X 1/8")	8
27	KEY / CLÉ	2
28	HEX KEY / CLÉ HEXAGONALE	1
29	STOPPER / BUTOIR	1
30	RAIL CAP / CAPUCHON DU RAIL	1
31	WALLJAMB CAP / CAPUCHON DU JAMBAGE	1
32	WALL MOUNT BRACKET GASKET / JOINT DU SUPPORT MURAL	1

PARTS LISTING / LISTE DES PIÈCES

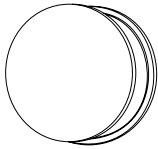
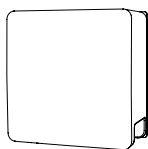
16 ROLLER OPTIONS / SÉLECTION DES ROULETTE	
A	B
	

17 FASTENER OPTIONS / SÉLECTION DES FIXATION	
C	D
