

## TOOLS AND MATERIAL REQUIRED / OUTILS ET MATÉRIAUX REQUIS

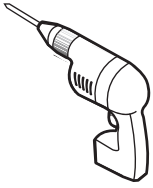

**DRILL**  
PERCEUSE

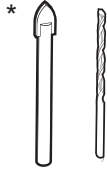

**1/4" & 1/8" DRILL BITS**  
MÈCHE 1/4" & 1/8"



**SCREWDRIVERS**  
TOURNEVIS

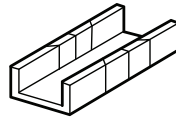

**MITER BOX**  
BOÎTE À ONGLETS



**WRENCH**  
CLÉ ANGLAISE



**MASKING TAPE**  
RUBAN DE MASQUAGE

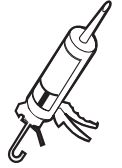

**SILICONE**  
SCÉLLANT



**PENCIL**  
CRAYON

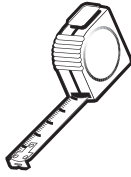

**TAPE MEASURE**  
RUBAN À MESURER



**MALLET**  
MAILLET

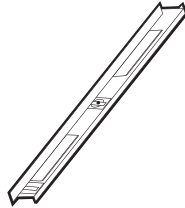

**LEVEL**  
NIVEAU

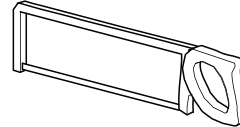

**HACKSAW WITH 32 TEETH**  
PER INCH BLADE

SCIE À MÉTAUX AVEC 32 DENTS  
PAR POUCE PAR LAME



**SAFETY GLASSES**  
LUNETTES DE SÉCURITÉ

**\* Use a 1/4" drill bit for ceramic when drilling into ceramic tiles**

**\* Utiliser une mèche de 1/4" destiné à céramique lors du perçage des tuiles en céramique.**

## DETECTING THE SEKUR SIDE ON THE GLASS / DÉTECTER LE CÔTÉ SEKUR SUR LE VERRE

The panels are treated differently on each side. Locate the SEKUR label that is installed on the **INTERIOR** side of the shower. Remove the sticker at the end of the installation.

*Les panneaux ont un traitement différent sur chaque côté. Localiser l'étiquette SEKUR qui est installée sur la face **INTÉRIEURE** de la douche. Retirer l'étiquette à la fin de l'installation.*

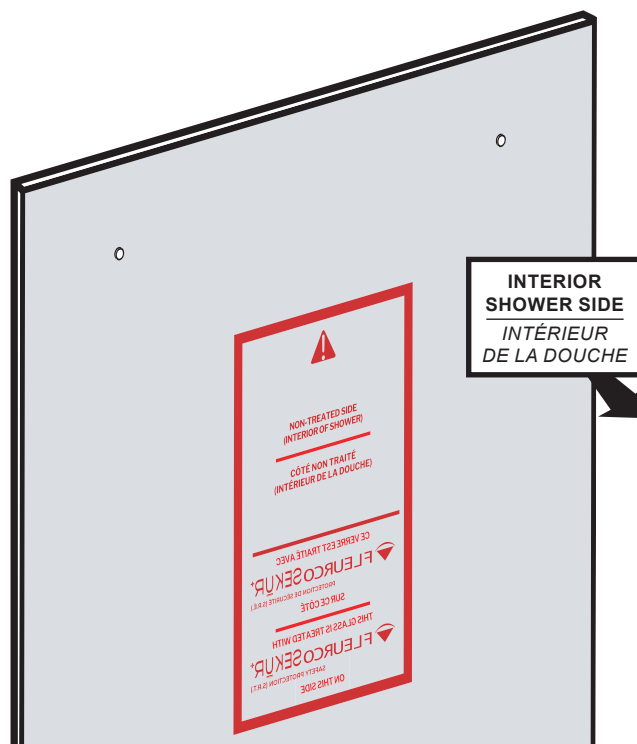

**POSSIBLE CONFIGURATIONS / CONFIGURATIONS POSSIBLES**

**SHOWER / DOUCHE**

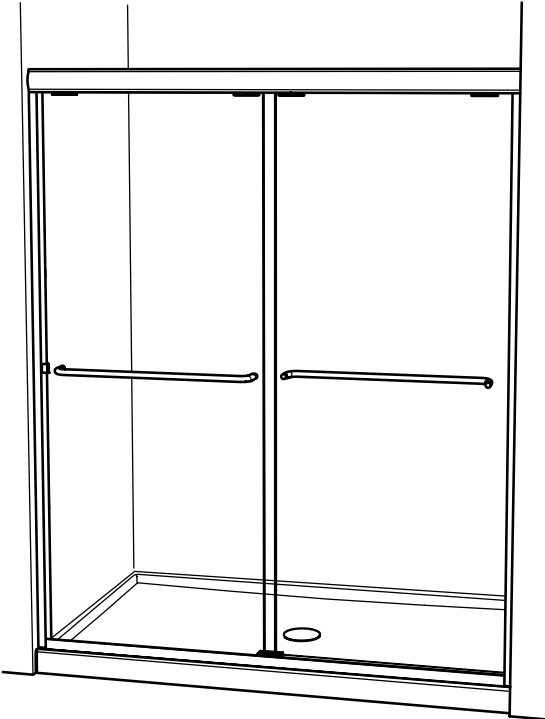

**TUB / BAIN**

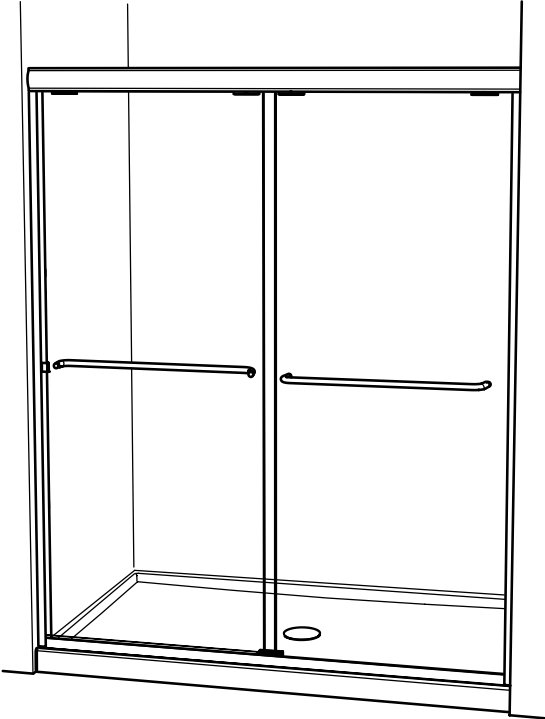
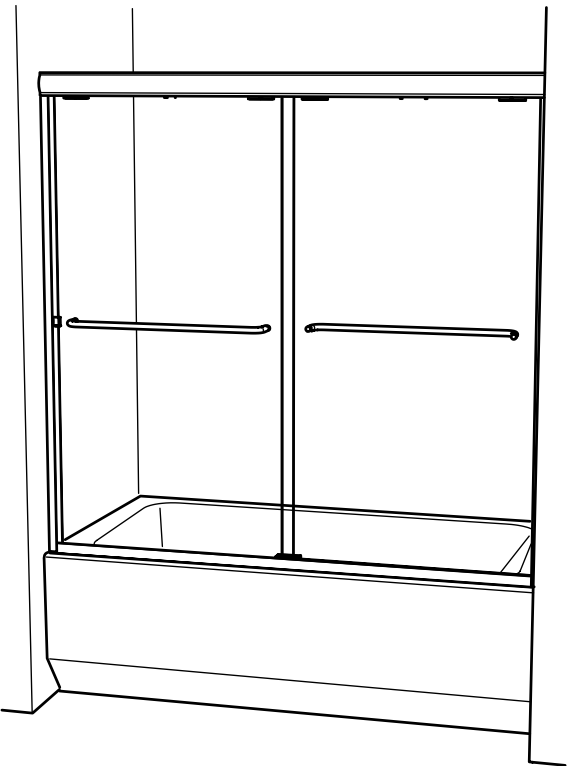

\*

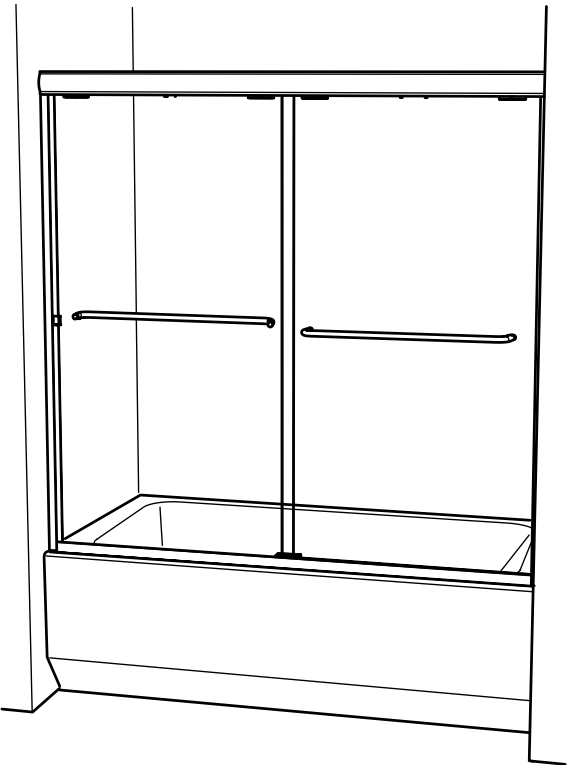

\* This configuration is illustrated in this manual.  
\* Cette configuration est illustrée dans ce manuel.

PARTS LISTING / LISTE DES PIÈCES

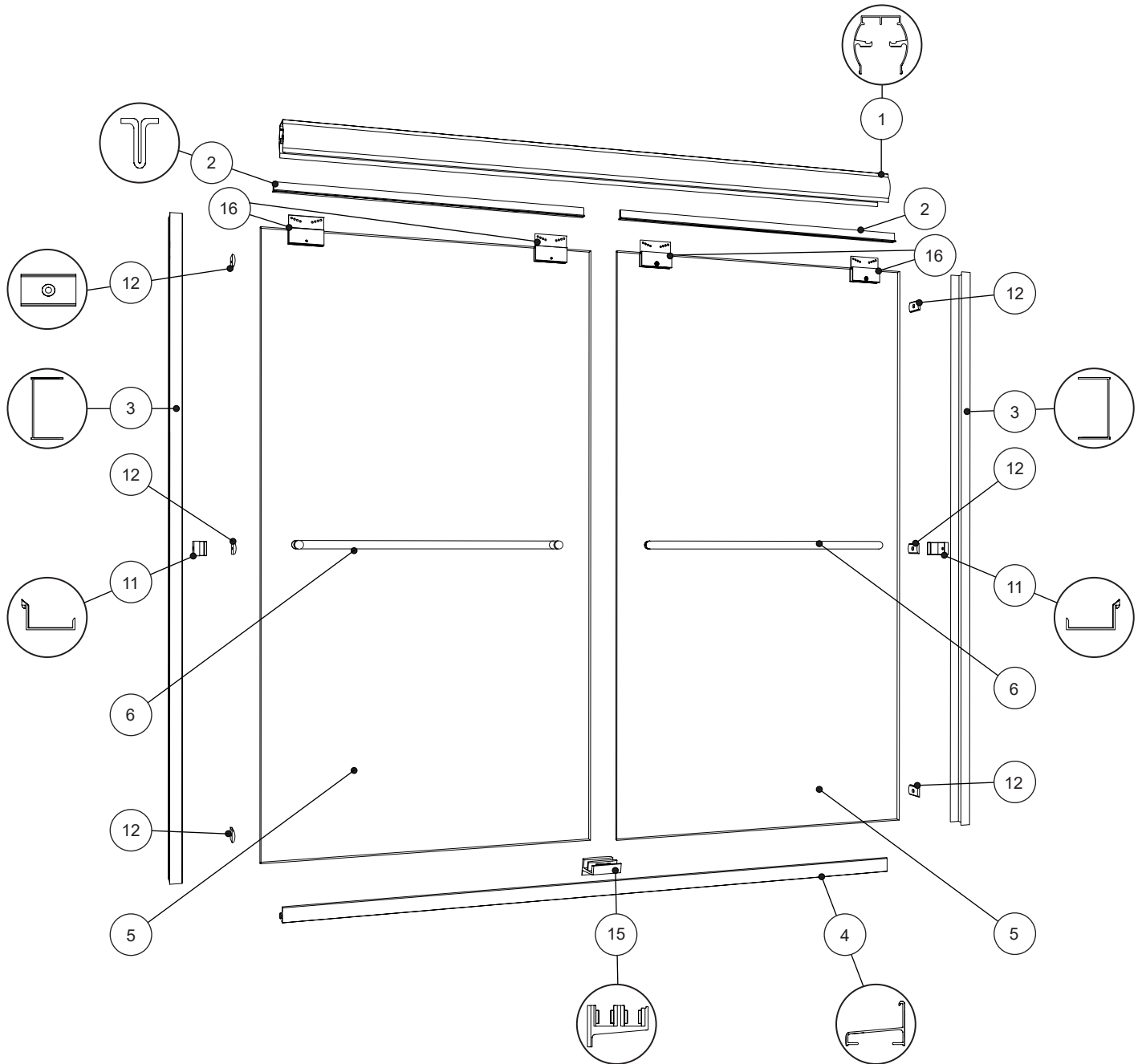

## PARTS LISTING / LISTE DES PIÈCES

ITEM	PARTS LISTING / LISTE DES PIÈCES	CODE	QTY
1	TOP RAIL / RAIL SUPÉRIEUR	COR-TRAIL-60-XX COR-PLUS-TRAIL-72-XX <sup>(a)</sup>	1
2	ANTI-JUMP / ANTI-SAUT	COR-ANTIJUMP-33-36	2
3	WALL JAMB / JAMBAGE	COR-WJAMB-75-XX COR-TUB-WJAMB-60-XX <sup>(d)</sup>	2
4	BOTTOM RAIL / RAIL INFÉRIEUR	COR-BRAIL-60-XX COR-BRAIL-61-XX <sup>(b)</sup> COR-BRAIL-72-XX <sup>(a)</sup>	1
5	GLASS PANEL / PANNEAU EN VERRE		2
6	HANDLE BAR / POIGNÉE	COR-HANDLEBAR-16-XX <sup>(c)</sup> COR-HANDLEBAR-24-XX	2
ITEM	HARDWARE LISTING / LISTE DE QUINCAILLERIE	CODE	QTY
7	WHEELS / ROUES	COR-ROLLER	8
8	PAN HEAD MACHINE SCREW #8 - 3/8" / VIS PAN #8 - 3/8"		8
9	PAN HEAD SCREW #8 - 1 1/2" / VIS PAN #8 - 1 1/2"		6
10	PAN HEAD SCREW #8 - 3/8" / VIS PAN #8 - 3/8"		1
11	SIDE GUIDE / GUIDE LATÉRAUX	COR-SG-XX	2
12	BUMPER / BUTOIR	COR-BUMPER (*)	6
13	KEY / CLÉ		1
14	WALL PLUG / CHEVILLE		7
15	CENTER GUIDE / GUIDE CENTRAL	COR-BGUIDE-10MM-XX	1
16	ROLLER BRACKET / SUPPORT DE ROULEAU	COR-ROLLER-BRACKET-10 (*)	4

COR-HRDBAG

<sup>(a)</sup> For 72" model only / Pour le modèle de 72po seulement

<sup>(b)</sup> For 61" model only / Pour le modèle de 61po seulement

<sup>(c)</sup> For 48" model only / Pour le modèle de 48po seulement

<sup>(d)</sup> For tub models only / Pour les modèles de baignoire seulement

(\*) Add -33 for black / Ajouter -33 pour noir

### HARDWARE LISTING / LISTE DE QUINCAILLERIE

