



**MARKETING  
MATERIALS**  
— CATALOGUE —

# TABLE OF CONTENTS

<b>PRINTED MATERIAL</b> .....	<b>3-7</b>
Catalogues .....	3
Brochures .....	3
Stickers & POP .....	4-5
Posters .....	6-7
<b>KITS &amp; SAMPLES</b> .....	<b>8</b>
<b>DISPLAYS</b> .....	<b>9-25</b>
Travelling Tub Door Display Racks.....	9
Travelling Shower & Tub Door Display Racks.....	10
Travelling Shower & Tub Display Racks - End Options.....	11
Multi Display .....	12
Freestanding In-line Single Shower Displays.....	13
Freestanding 2 Sided Single Shower Displays.....	14
Freestanding Corner Single Shower Displays .....	15
Mini Shower Doors Display .....	16
Shower Base Displays.....	17-18
Mini Tubs Displays.....	19
Wall-mounted Luna Display.....	20
Wall-mounted Luna Vizo Display .....	21
Luna Stak Vanities Display .....	22
Wall-mounted Veritas Niche Displays.....	23
Drain Displays .....	24
Fibo Flex by Fleurco Wall System Display .....	25
<b>PROMOTIONAL ITEMS</b> .....	<b>26</b>

# PRINTED MATERIAL

## CATALOGUES



**Shower Doors, Bases, Fibo by Fleurco, Accessories, Luna collection & Bathtubs**

**Empty Binder**

QTY per case: 24

MM-FLBINDER

**Catalogue Inserts**

QTY per case: 5

CA-EN: MM-INS-CAN23-24

CA-FR: MM-INS-FR23-24

US-EN: MM-INS-US23-24

## BROCHURES

**Shower Doors**

MM-LEAFLET-DOORS-22-ENG



**Shower Bases**

MM-LEAFLET-BASE-22-ENG



**Bathtubs**

MM-LEAFLET-TUBS-ENG



**Luna Mirrors & Medicine Cabinets**

MM-LEAFLET-LUNA-ENG



**Luna Vanities**

MM-LEAFLET-VANITIES-ENG



**Fibo by Fleurco Wall Systems**

MM-BROCHURE-FIBO-ENG



# PRINTED MATERIAL

## STICKERS & POP

Fibo by Fleurco Transfer Sticker 4 2/5" x 2 1/4"

MM-FIBO-STICKER



Microtek® Clear Sticker 6 1/2" x 4 3/4"

MM-MICROTEK2-STICKER-EN



### GLASS SURFACE PROTECTION

- Repels water and resists stains from soap scum build-up
- Easy to clean - eliminates the need for harsh abrasives
- Antibacterial properties
- 10 year warranty

[www.fleurco.com](http://www.fleurco.com)

FleurcoSEKUR+ Sticker 6 1/4" x 2 1/4"

MM-SEKUR-STICKER



FleurcoSEKUR+ Clear Sticker 7" x 3 1/2"

MM-SEKURG-STICKER-EN



Mix & Match POP 4 3/4" x 9 1/2"

MM-MIXMATCH-STICKER- EN





# PRINTED MATERIAL

## STICKERS & POP

### Luna Medicine Cabinets POP 6 4/5" x 6 3/5"

MM-POP-MED-CABINET-EN

PLACEMENT OF POP



**MEDICINE CABINETS**

**FEATURES**

- Copper-free mirror
- Choice of flat or beveled edges
- Wall mounted or recessed installation (surface mount kit included)
- Soft-close door with Blum hinges
- 8mm, ultra clear adjustable glass shelves (additional glass shelves sold separately)
- Available in single view, bi-view and tri-view in multiple sizes

5 year limited warranty

FLEURCO® www.fleurco.com

### Luna Lighted Mirrors POP 6 4/5" x 6 3/5"

MM-POP-LIGHTED-MIRROR-EN

PLACEMENT OF POP



**LIGHTED MIRRORS**

**FEATURES**

- Energy-efficient LED warm white light, suitable for makeup application and shaving
- Copper-free and distortion-free mirror
- De-fogger included (excluding wardrobe mirrors)
- Safety film backing
- ON-OFF switch easily located and compatible with a wall dimmer
- Different models available in multiple configurations

5 year limited warranty

UL CERTIFIED

FLEURCO® www.fleurco.com

### Horizon & Skyline 6 3/4" x 11"

MM-POP-HORIZONSKYLINE-ENG

HORIZON SKYLINE



CHOOSE YOUR STYLE

- Space saving, frameless sliding door & fixed panel
- 5/16" (8 mm) clear safety tempered glass
- Detachable bottom guide to facilitate maintenance
- UV bonded door magnets ensure a water-tight seal
- Available configurations: In-line, 2 sided & tub
- Available finishes: Chrome, brushed nickel & matte black
- Available heights: 75", 79" & 86"

Microtek® 10 year limited warranty

FLEURCO® www.fleurco.com

### FL Connect 7" x 5"

MM-FLCONNECT-STICKER

FLEURCOconnect

FREESTANDING TUB INSTALLATION MADE EASY



#1 SOLUTION

- A fast and easy way to install a freestanding tub
- Less installation time
- Ideal for tight spaces with minimum access
- Easy access for repairs

FLEURCO® www.fleurco.com

# PRINTED MATERIAL

## POSTERS

**Gemini Plus 36" x 24" MM-POSTER-GEM**



**Latitude Pivot 36" x 24" MM-POSTER-LATPIVOT**



**Elera 36" x 24" MM-POSTER-ELERA**



**Novara Plus 36" x 24" MM-POSTER-NOVPLUS**



**Select Platinum Lexus 36" x 24" MM-POSTER-LEXUS**



**Apollo 36" x 24" MM-POSTER-APOLLO**

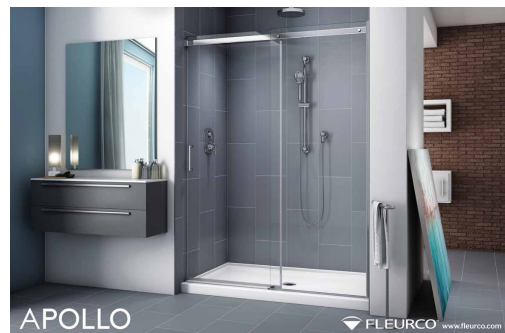

**Walk-in Showers 36" x 24" MM-POSTER-WALKIN**



**Fibo by Fleurco 24" x 36" MM-POSTER-FIBO-EN**

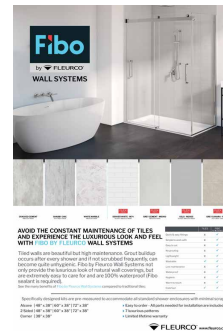

Please contact the Marketing Department for product availability.  
Marketing catalogue last modified 2025-03-13

# PRINTED MATERIAL

## POSTERS

Aria 36" x 24" MM-POSTER-ARIA



Opus 36" x 24" MM-POSTER-CABALETTA



Aria Stone 36" x 24" MM-POSTER-ARIASTONE



# KITS & SAMPLES

## Microtek® Sample

MM-MICROTEK-SAMPLE



## Finishes Sample Kit

MM-FIN-SAMPLE-KIT



## Luna Artus Frame Samples 6 1/2" W x 6" H x 1/2" D

DSP-ARTUS-TRIMS



## Tavia Solid Surface Samples 6 1/2" W x 6 1/8" H x 7 1/8" D

DSP-TAVIA-BOX



## Aria Stone Solid Surface Samples 6 1/2" W x 6 1/8" H x 7 1/8" D

DSP-ARIASTONE-BOX



## Vespero Sample 8" W x 8" H x 2" D

DSP-VSP-SAMPLE



## Clear Glass Sample 2 1/2" W x 2 1/2" H x 1/4" D

MM-GLASS-CLEAR

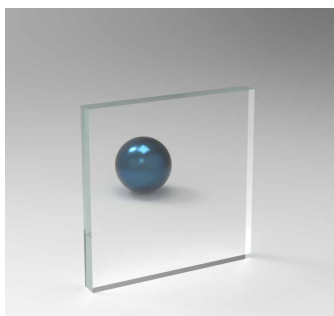

## Mist Glass Sample 4 1/2" W x 4 1/2" H x 5/16" D

DSP-MISTGLASS-SAMPLE

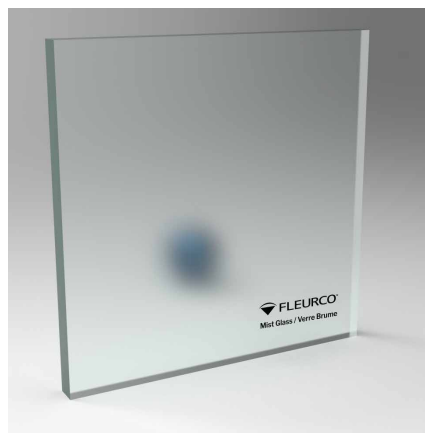

Please contact the Marketing Department for product availability.  
Marketing catalogue last modified 2025-03-13

# DISPLAYS

## TRAVELLING TUB DOOR DISPLAY RACKS



### Choose up to 5 tub doors\*

\*The travelling racks hold 5 tub doors of 60" in width, for optimal results we recommend 4 doors.

### Optional display ends (choose up to 2)

Elera Single Pivot Door  
[ELEP23-\\_-40-79†](#)

Aria Mini Tubs Display  
 (add 13" to width)

Opus Mini Tubs Display  
 (add 8" to width)

Select Kara Single Pivot Door  
 (add 6" to width)  
[PKT24-\\_-40-79†](#)

†Available finishes:

[11](#) (Chrome)

[25](#) (Brushed Nickel)

[33](#) (Matte Black)

See page 11 for more information on display end options

DOOR WIDTH	DISPLAY CODE	DESCRIPTION	DIMENSIONS
60"	<a href="#">WHDENFTD</a>	White display rack without display end	62 ¾" W x 29" D x 89" H
	<a href="#">BLKDENFTD</a>	Black display rack without display ends	62 ¾" W x 29" D x 89" H
	<a href="#">WHDENFTD-1</a>	White display rack with 1 display end	62 ¾" W x 29" D x 89" H
	<a href="#">BLKDENFTD-1</a>	Black display rack with 1 display end	62 ¾" W x 29" D x 89" H
	<a href="#">WHDENFTD-2</a>	White display rack with 2 display ends	62 ¾" W x 29" D x 89" H
	<a href="#">BLKDENFTD-2</a>	Black display rack with 2 display ends	62 ¾" W x 29" D x 89" H

Please contact the Fleurco Order Desk for pricing information.  
 Display racks cannot be shipped assembled.  
 Marketing catalogue last modified 2025-03-13



# DISPLAYS

## TRAVELLING SHOWER & TUB DOOR DISPLAY RACKS



### Choose up to 5 doors\*

\*The travelling racks hold 3 tub doors and 2 shower doors of 48" or 60"

### Optional display ends (choose up to 2)

Elera Single Pivot Door

[ELEP23-\\_-40-79†](#)

Aria Mini Tubs Display (add 13" to width)

Opus Mini Tubs Display (add 8" to width)

Select Kara Single Pivot Door (add 6" to width)

[PKT24-\\_-40-79†](#)

†Available finishes:

[11](#) (Chrome)

[25](#) (Brushed Nickel)

[33](#) (Matte Black)

See page 11 for more information on display end options

Tubs not included.

DOOR WIDTH	DISPLAY CODE	DESCRIPTION	DIMENSIONS
48"	<a href="#">WHDHTDSD-3</a>	White display rack with 0, 1 or 2 display ends.	51" W x 29" D x 89" H**
	<a href="#">BLKDHTDSD-3</a>	Black display rack with 0, 1 or 2 display ends.	51" W x 29" D x 89" H**
60"	<a href="#">WHTMTDSD-1</a>	White display rack with 1 display end.	67" W x 29" D x 89" H
	<a href="#">BLKMTDSD-1</a>	Black display rack with 1 display end.	67" W x 29" D x 89" H
	<a href="#">WHTMTDSD-2</a>	White display rack with 2 display ends.	71" W x 29" D x 89" H
	<a href="#">BLKMTDSD-2</a>	Black display rack with 2 display ends.	71" W x 29" D x 89" H
	<a href="#">WHDHTDSD-4†</a>	White display rack with 0, 1 or 2 display ends.	63" W x 29" D x 78" H**
	<a href="#">BLKDHTDSD-4†</a>	Black display rack with 0, 1 or 2 display ends.	63" W x 29" D x 78" H**

†These racks cannot accommodate 79" tall shower doors. Display height is lower than other models.

\*\*Dimensions without display ends.

Please note that adding a mini tub display to the ends will increase the length by approximately 12".

Please contact the Fleurco Order Desk for pricing information.  
Display racks cannot be shipped assembled.  
Marketing catalogue last modified 2025-03-13

# DISPLAYS

## TRAVELLING SHOWER & TUB DISPLAY RACKS - END OPTIONS

**Elera Pivot Shower Door**

ELEP23-\_-40-79†



**Select Kara Pivot Door**

PKT24-\_-40-79†



†Available finishes: 11 (Chrome), 25 (Brushed Nickel), 33 (Matte Black)

**Aria Mini Tub Display\* 25" x 75"**

ARDSD-2



**Opus Mini Tub Display\* 25" x 75"**

OPDSD-2



\*See page 19 for ordering information

Please contact the Fleurco Order Desk for pricing information.  
Display racks cannot be shipped assembled.  
Marketing catalogue last modified 2025-03-13

# DISPLAYS

## MULTI DISPLAY

**4 in-line shower doors**

**Area to attach mirrors, medicine cabinets or accessories displays on both sides**

**Optional wheels**

Select:

4 in-line shower doors

Veritas niche display (see page 23)

2 Luna LED mirrors, medicine cabinets or LED medicine cabinets



BLKDSP-MULTI-60



WHDSP-MULTI-60

DOOR WIDTH	PRODUCT CODE	DESCRIPTION	DIMENSIONS*
48"	WHDSP-MULTI-48	White multi display	54" W x 29" D x 89" H
	BLKDSP-MULTI-48	Black multi display	54" W x 29" D x 89" H
60"	WHDSP-MULTI-60	White multi display	66" W x 29" D x 89" H
	BLKDSP-MULTI-60	Black multi display	66" W x 29" D x 89" H

\*91 1/2" height with wheels

Please contact the Fleurco Order Desk for pricing information.  
Display racks cannot be shipped assembled.  
Marketing catalogue last modified 2025-03-13





# DISPLAYS

## FREESTANDING IN-LINE SINGLE SHOWER DISPLAYS

### In-line 48" x 36"

50" W x 38" D x 86" H

### In-line 60" x 36"

62" W x 38" D x 86" H

### STEP 1: Choose wood for display

White: [WHDSP-INL](#)

Black: [BLKDSP-INL](#)

### STEP 2: Choose in-line door 48" or 60"

Refer to Shower Doors section in catalogue

### STEP 3: Choose base 48" or 60" (match to selected door size)

Refer to Bases booklet in catalogue

### STEP 4: (CAD ONLY) Choose Fibro by Fleurco Wall System



**CRACKED CEMENT**  
2204  
(SMOOTH FINISH)



**WHITE MARBLE**  
2273  
(SMOOTH FINISH)



**SHABBY CHIC**  
2898  
(TEXTURED FINISH)



**DENVER WHITE**  
(M74) 3091  
(GLOSSY SMOOTH FINISH)

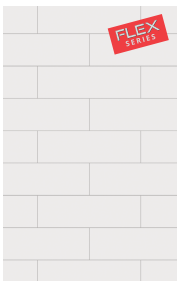

**GREY CEMENT**  
(M6060) 2145  
(SMOOTH FINISH)

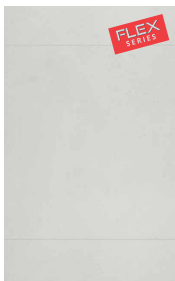

**OSLO**  
(M3005) 4063  
(GLOSSY SMOOTH FINISH)



**GREY SAHARA**  
(M6040) 4746  
(TEXTURED FINISH)

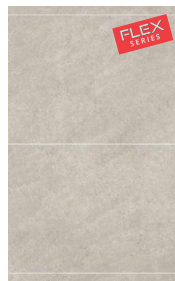

Please contact the Fleurco Order Desk for pricing information.  
Display racks cannot be shipped assembled.  
Marketing catalogue last modified 2025-03-13

# DISPLAYS

## FREESTANDING 2 SIDED SINGLE SHOWER DISPLAYS

### 2 Sided 48" x 36"

50" W x 38" D x 86" H

### 2 Sided 60" x 36"

62" W x 38" D x 86" H

### STEP 1: Choose wood for display

White: [WHDSP-INLRP](#)

Black: [BLKDSP-INLRP](#)

### STEP 2: Choose 2 sided door 48" or 60"

Refer to Shower Doors section in catalogue

### STEP 3: Choose base 48" or 60" (match to selected door size)

Refer to Bases booklet in catalogue

### STEP 4: (CAD ONLY) Choose Fibro by Fleurco Wall System



**CRACKED CEMENT**  
2204  
(SMOOTH FINISH)



**WHITE MARBLE**  
2273  
(SMOOTH FINISH)



**SHABBY CHIC**  
2898  
(TEXTURED FINISH)



**DENVER WHITE**  
(M74) 3091  
(GLOSSY SMOOTH FINISH)

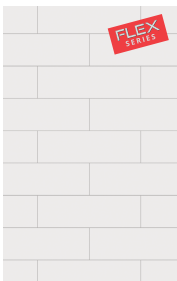

**GREY CEMENT**  
(M6060) 2145  
(SMOOTH FINISH)

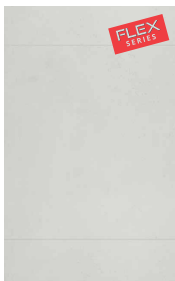

**OSLO**  
(M3005) 4063  
(GLOSSY SMOOTH FINISH)



**GREY SAHARA**  
(M6040) 4746  
(TEXTURED FINISH)

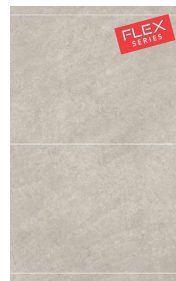

Please contact the Fleurco Order Desk for pricing information.  
Display racks cannot be shipped assembled.  
Marketing catalogue last modified 2025-03-13

# DISPLAYS

## FREESTANDING CORNER SINGLE SHOWER DISPLAYS

### Corner

40" W x 40" D x 86" H

### STEP 1: Choose wood for display

White: [WHDSP-CRN](#)

Black: [BLKDSP-CRN](#)

### STEP 2: Choose corner door 40" x 40" or less

Refer to Corner Doors section in catalogue

### STEP 3: Choose base (match to selected door size)

Refer to Bases booklet in catalogue

### STEP 4: (CAD ONLY) Choose Fibro by Fleurco Wall System



**CRACKED CEMENT**  
[2204](#)  
(SMOOTH FINISH)



**WHITE MARBLE**  
[2273](#)  
(SMOOTH FINISH)



**SHABBY CHIC**  
[2898](#)  
(TEXTURED FINISH)



**DENVER WHITE**  
[\(M74\) 3091](#)  
(GLOSSY SMOOTH FINISH)

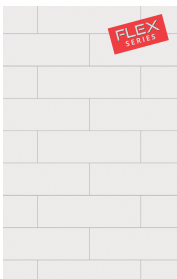

**GREY CEMENT**  
[\(M6060\) 2145](#)  
(SMOOTH FINISH)



**OSLO**  
[\(M3005\) 4063](#)  
(GLOSSY SMOOTH FINISH)

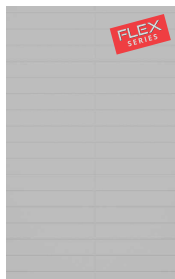

**GREY SAHARA**  
[\(M6040\) 4746](#)  
(TEXTURED FINISH)

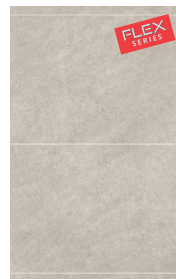

Please contact the Fleurco Order Desk for pricing information.  
Display racks cannot be shipped assembled.  
Marketing catalogue last modified 2025-03-13

# DISPLAYS

## MINI SHOWER DOORS DISPLAY\*

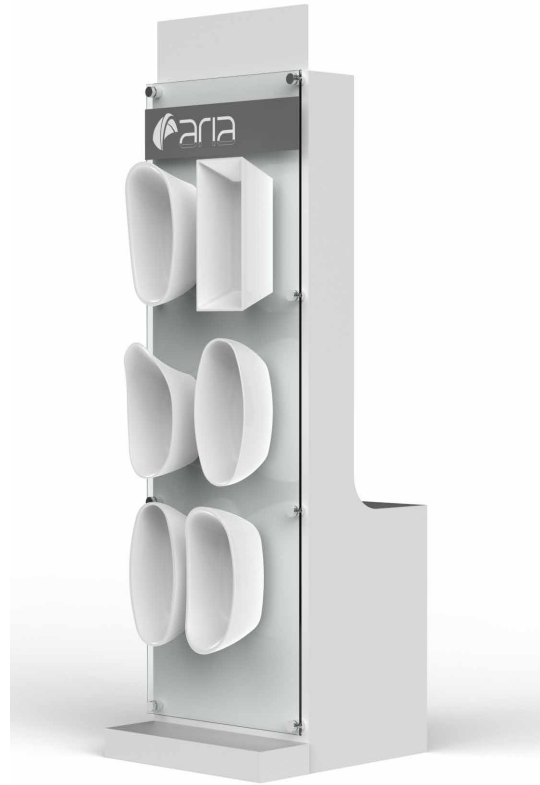

Available in white only

[DSP-WHMTD-001](#) - Without tubs

[DSP-WHMTD-002](#) - With tubs

25 1/2" W x 20 5/8" D x 86" H

### Choose 3 doors and indicate the position (1, 2 or 3)

Mini Cordoba - Brushed Nickel

Mini Select K2 - Chrome

Mini Novara Plus - Chrome

Mini Platinum (3 only) - Chrome

Mini Apollo - Chrome

Mini Pura (3 only) - Chrome

Mini Horizon - Brushed Nickel or Matte Black

Mini Skyline - Matte Black

Mini Gemini - Brushed Nickel, Matte Black or Brushed Gold

Mini Latitude - Matte Black (With FleurcoSEKUR+ Safety Protection.)

Mini Elera (3 only) - Chrome, Brushed Nickel or Matte Black

\*Shower doors not included. Wall-mount mini tub display may be added. See page 19.

If ordering a full sized tub and mini tubs at a later date, be sure to order the -002 version of this tower, which has a stabilizing foot added for stability.

Please contact the Fleurco Order Desk for pricing information.

Display racks cannot be shipped assembled.

Marketing catalogue last modified 2025-03-13

# DISPLAYS

## SHOWER BASE DISPLAYS

### Mini Shower Bases Display



Available in white only

[SBPMBD-A](#)

22" W x 28" D x 56" H

**Mini bases included (no choices):**

Mini Quad (18" x 24") [MINI-ADQ3648-18](#)

Mini Flanged (18" x 24") [MINI-ABF4836-18-3](#)

Mini Neo (18" x 18") [MINI-ALN36-18-B](#)

Mini Linear Drain (18" x 24") [MINI-ABE3648-18-11-B](#)

### Aurora Textured Base Display\*



[DSP-AURORA-1](#)

24" W x 20 5/8" D x 48" H

\*Textured base is included

Choose between 3 textures in Matte Black (Slate, Wood or Stone)

Desired base must be specified when ordering this display

For 48" x 36" bases only

Drain must be secured through frame

Drain **MUST** be ordered with the display for mounting

Choose drain colour (Chrome, Brushed Nickel or Matte Black)

See Bases booklet for base & drain codes

# DISPLAYS

## SHOWER BASE DISPLAYS

### Tavia Solid Surface Base Display\*



#### DSP-TAVIA-1

24" W x 20 5/8" D x 48" H

\*Solid surface base is included

Choose between 3 matte finishes (White, Stone Grey or Cocoa), and 2 textures (Slate or Smooth)

Desired base must be specified when ordering this display

For 48" x 36" bases only

Drain must be secured through frame

Drain **MUST** be ordered with the display for mounting

Only Matte Black drain cover is available for Tavia bases

See Bases booklet for base & drain codes

### Tavia Sticker 15" x 10"

MM-TAVIA-STICKER-EN



# DISPLAYS

## MINI TUBS DISPLAYS\*

**Aria Mini Tubs**  
Wall-mount Display Panel 25" x 75"



ARDSD-2†



AR-MINITUB-KIT

**This mini tub kit includes:**

- Mini Verismo
- Mini Calando
- Mini Arpeggio
- Mini Molto
- Mini Octave
- Mini Voce

**Opus Mini Tubs**  
Wall-mount Display Panel 25" x 75"



OPDSD-2†



OP-MINITUB-KIT

**This mini tub kit includes:**

- Mini Alto
- Mini Libretto
- Mini Concerto
- Mini Rhapsody
- Mini Waltz
- Mini Ossia

\*Mini tub displays can also be mounted on a travelling (pages 9-10) or mini shower door (page 16) display rack.

†Mini tubs sold separately. You must order the display panel and the mini tub kit.

# DISPLAYS

## WALL-MOUNTED LUNA DISPLAY\*

---

2 Sided Wall Mirror Display  
36" W x 4" D x 86" H

DSP-LUNA-2



\*Mirror not included.

Please contact the Fleurco Order Desk for pricing information.  
Display racks cannot be shipped assembled.  
Marketing catalogue last modified 2025-03-13



# DISPLAYS

## WALL-MOUNTED LUNA VIZO DISPLAY

Backlit Wall-Mounted Luna Vizo Display (wall-mount models)\*  
25" W x 7" D x 19 3/4" H†

DSP-VIZO-1



\*Mirrors are included.

†Depth of display with mirrors installed is 7". Total depth is 16 9/32" with mirrors fully extended. The depth of the board without the mirrors is 2".

# DISPLAYS

## LUNA STAK VANITIES DISPLAY

### 4 Sided Tower Display

DSP-LUNA-STAK



Front View



Back View

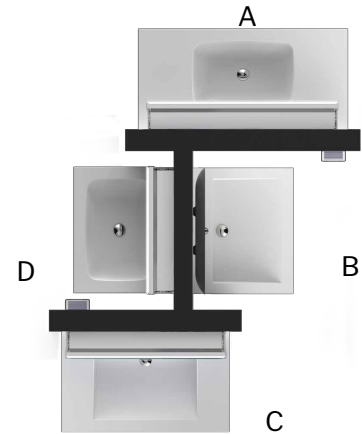

Top View

### STEP 1: Order display

White DSP-LUNA-STAK

### STEP 2: Order vanities

Choose up to 4 vanities. Refer to Vanities section in the Luna booklet.

WALL	VANITY SIZE
A	39"
B	24"
C	32"
D	24"

OPTIONAL: Refer to Luna booklet page 60 for decorative drains & pipes.

### STEP 3: Order Luna mirror of choice

Refer to the Luna booklet to choose your LED Mirror, Medicine Cabinet or LED Medicine Cabinet.

You must choose a mirror size to match the vanity wall size.

### Display dimensions

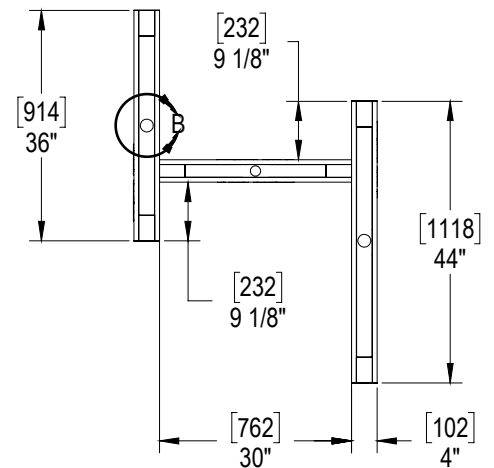

# DISPLAYS

## WALL-MOUNTED VERITAS NICHE DISPLAYS\*

**12" x 12" Niche Display**  
**16" W x 19" H**

DSP-NICHE-1



**16" x 12" Niche Display**  
**20" W x 19" H**

DSP-NICHE-2



**24" x 12" Niche Display**  
**28" W x 19" H**

DSP-NICHE-3



\*Chrome niche included

# DISPLAYS

## DRAIN DISPLAYS

### FleurcoCONNECT Drain 14" W x 14" D x 18 1/2" H

DSP-FLCONNECT-ABS (ABS model)  
DSP-FLCONNECT-PVC (PVC model)



Top View



### RapidCONNECT® Drain 14" W x 14" D x 11" H

WHDRDCR-ABS-1 (ABS model)  
WHDRDCR-PVC-1 (PVC model)  
WHDRDCR-CI-1 (Cast Iron model)



Top View



# DISPLAYS

## FIBO FLEX BY FLEURCO WALL SYSTEM DISPLAY

13 3/4" W x 16 9/10" D x 23 4/5" H

DSP-FIBO-1



Please contact the Fleurco Order Desk for pricing information.  
Marketing catalogue last modified 2025-03-13

# PROMOTIONAL ITEMS

## Bloc Notes

MM-BLOCNOTE



## Notepad & Pen Set

MM-NOTEPAD



## Pen

MM-PEN



## Tote

MM-TOTEBAGS



## Mug

MM-MUG



\*Limited quantities available