

Guide d'installation et d'utilisation • Installation and User's Guide

Tablette • Shelf

Lire toutes les instructions attentivement avant de commencer l'installation. Le bon respect des instructions garantie une installation sûre. Nettoyer régulièrement la surface pour qu'elle reste brillante. Utiliser seulement un nettoyant neutre et un tissu doux. Ne pas utiliser de nettoyant chimique ou d'éponge abrasive.

Read all instructions carefully before proceeding. Following the instructions closely will ensure a safe and secure installation. Clean the surface periodically to maintain a bright surface. Use only a mild-cleaner and soft cloth. Do not use chemicals or scouring pads.

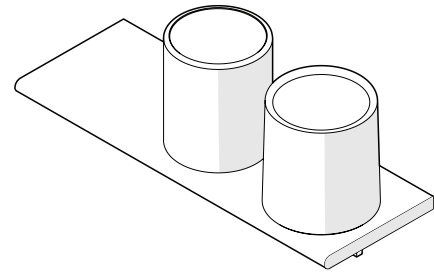

LISTE DES PIÈCES / PARTS LISTING

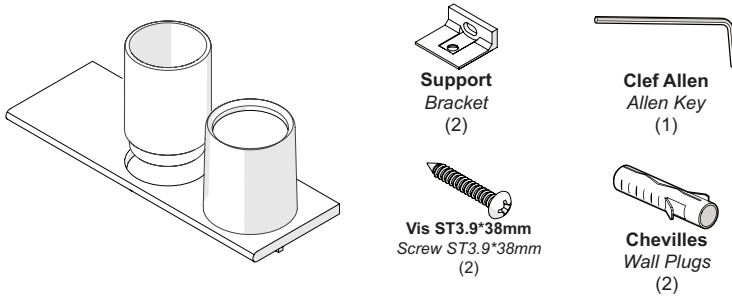

CARACTÉRISTIQUES / SPECIFICATIONS

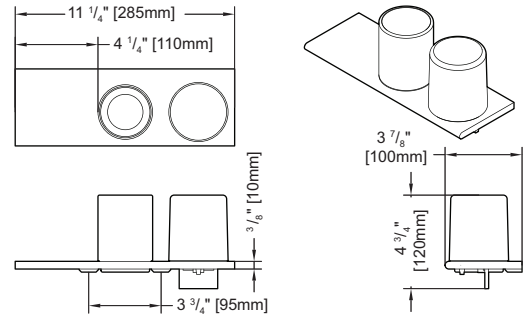

OUTILS REQUIS / REQUIRED TOOLS

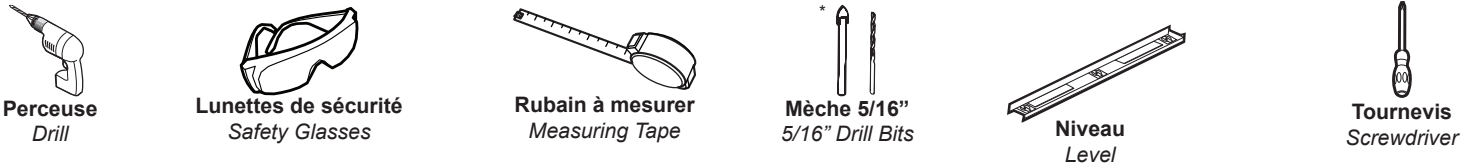

* Use a 5/16" drill bit when drilling into ceramic tiles.
* Utiliser une mèche de 5/16" pour percer des tuiles en céramique.

INSTALLATION / INSTALLATION

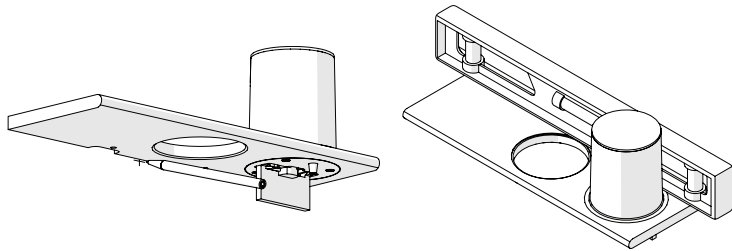

Placer la tablette sur le mur à niveau et marquer le centre / Place the shelf on the wall with a level, and mark the center

INSTALLATION / INSTALLATION

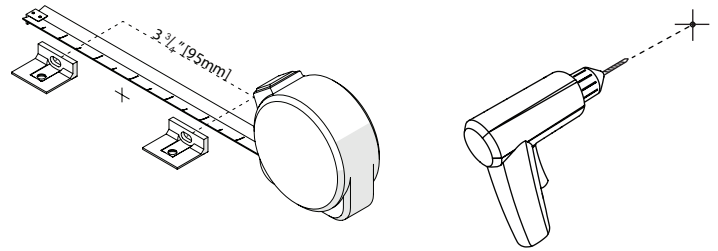

Vérifier la mesure, marque les points de perçage et percer / Check the measurement, mark the drilling locations and drill

INSTALLATION / INSTALLATION

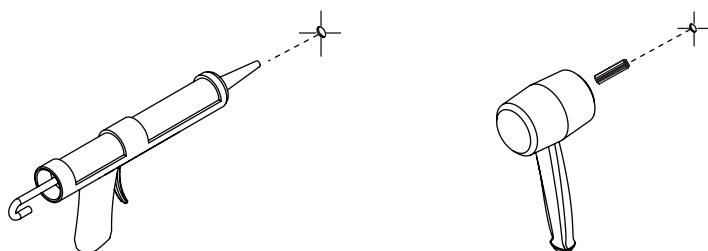

Siliconer et insérer les chevilles / Silicone and insert the wall plugs

INSTALLATION / INSTALLATION

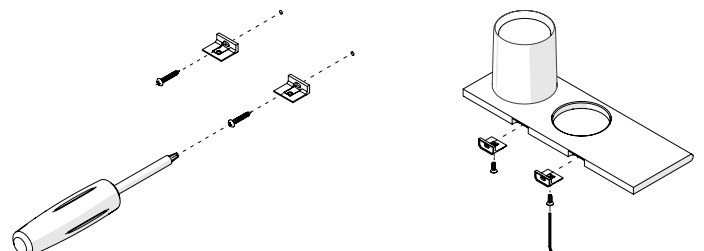

Installer les supports et la tablette / Install the brackets and the shelf