

TOOLS REQUIRED / OUTILS REQUIS

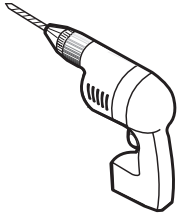

DRILL
NIVEAU

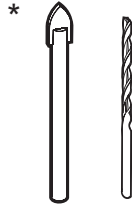

1/4" & 1/8" DRILL BITS
MÈCHE 1/4" & 1/8"

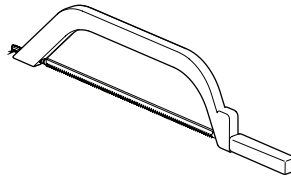

HACKSAW
SCIE À MÉTAUX

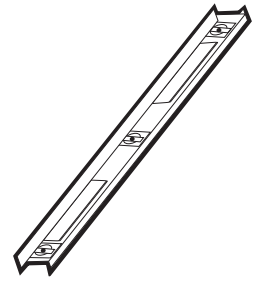

LEVEL
NIVEAU



PENCIL
CRAYON

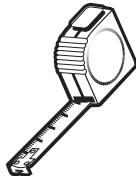

MEASURE TAPE
RUBAN À MESURER



SCREWDRIVER
TOURNEVIS

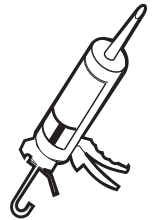

SILICONE
SCCELLANT

* Use a 1/4" drill bit for ceramic when drilling into ceramic tiles • * Utiliser une mèche à céramique de 1/4" lors du perçage des tuiles en céramique.

POSSIBLE CONFIGURATIONS / CONFIGURATIONS POSSIBLES

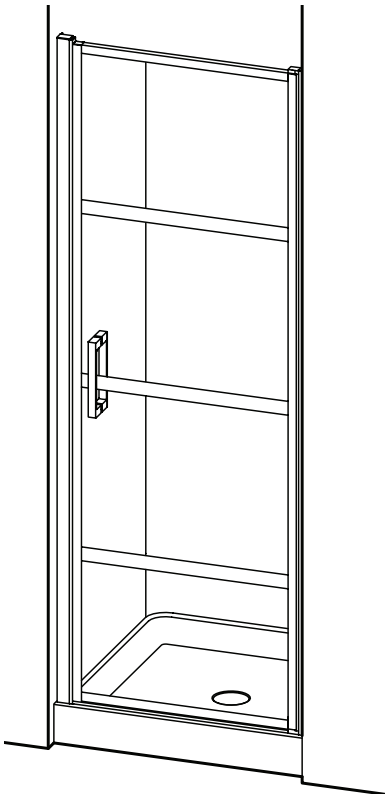

Reversible • Réversible



THIS DOOR OPENS OUTWARDS AND INWARDS. PAY ATTENTION TO PLUMBING LOCATION BEFORE STARTING INSTALLATION

CETTE PORTE S'OUVRE VERS L'INTÉRIEUR ET L'EXTÉRIEUR. FAIRE ATTENTION A L'EMPLACEMENT DE LA PLOMBERIE AVANT DE COMMENCER L'INSTALLATION



THE INSTALLATION SHOWN IS BASED ON PLUMB FINISHED WALLS AND A LEVELLED BASE. IF THESE CONDITIONS ARE NOT MET, PLEASE ADJUST ACCORDINGLY.

L'INSTALLATION ILLUSTRÉE EST BASÉE SUR DES MURS FINIS D'APLOMB ET UNE BASE DE DOUCHE NIVELÉE. SI CES CONDITIONS NE SONT PAS PRÉSENTES, VEUILLEZ AJUSTER EN CONSÉQUENCE

**PARTS AND HARDWARE LISTING /
LISTE DES PIÈCES ET QUINCAILLERIE**

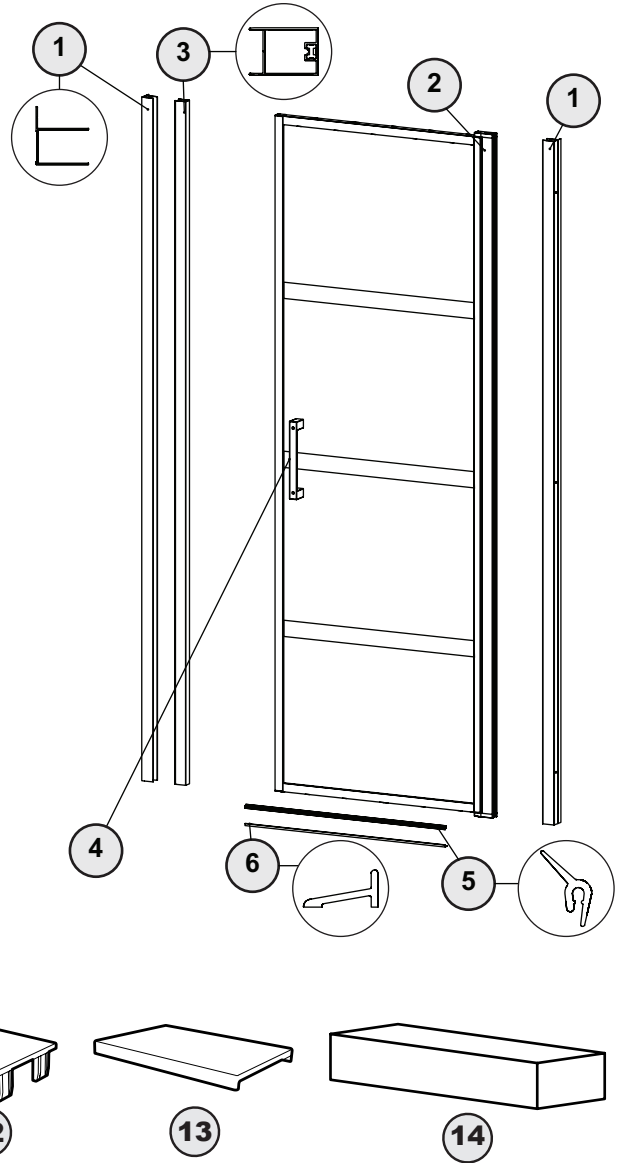
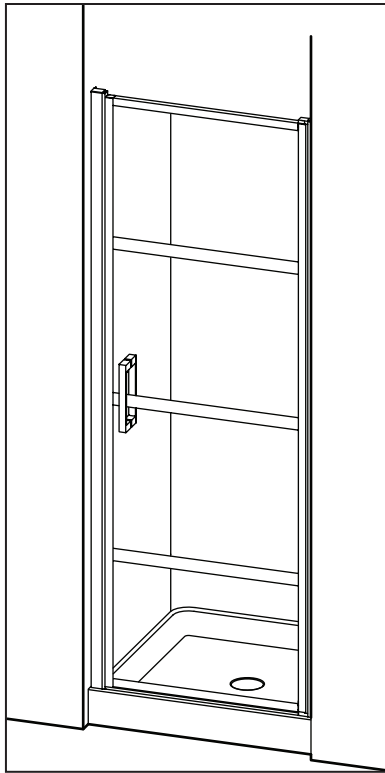

ITEM	FLEURCO CODE	PARTS AND HARDWARE / PIÈCES ET QUINCAILLERIE	QTY
1	LA-WJAMB-33-79	WALL JAMB / JAMBAGE	2
2		DOOR PANEL ASSEMBLY / ASSEMBLAGE DU PANNEAU DE PORTE	1
3	LAP-MAGEXP-33-79	MAGNETIC EXPANDER / EXTENSEUR MAGNÉTIQUE	1
4		HANDLE / POIGNÉE	1
5	COEX-LA415-40-33	THRESHOLD GASKET / JOINT DE SEUIL	1
6	PLAT-THRESH-33-72	THRESHOLD / SEUIL	1
7		WALL PLUG / CHEVILLE	6
8		PAN HEAD SCREW / VIS À TÊTE CYLINDRIQUE	6
9		PAN HEAD SELF DRILLING SCREW / VIS PAN AUTO-PERÇANTE	6
10		BACK SCREW CAP / CAPUCHON COUVRE-VIS ARRIÈRE	12
11		SCREW CAP / CAPUCHON COUVRE-VIS	12
12	LA-RP-CAP-33-79	FRAME CAP / CAPUCHON DU CADRE	1
13	LA-WJCAP-33	WALL JAMB CAP / CAPUCHON DU JAMBAGE	2
14		SHIM / CALE	1