

CODE EXAMPLE AND HOW TO ORDER YOUR SHOWER ENCLOSURE 2

SELECT YOUR OPTIONS 3

FEATURES 4-5



CRONOS WALL-MOUNT HINGE DOOR 6-7



CRONOS CUBE WALL-MOUNT HINGE DOOR **WITH RETURN PANEL** 8-9



CRONOS IN-LINE WALL-MOUNT HINGE DOOR AND FIXED PANEL 10-11



HYPERION IN-LINE GLASS-TO-GLASS HINGE DOOR AND FIXED PANEL 12-13



CRONOS 2 SIDED WALL-MOUNT HINGE DOOR AND FIXED PANEL **WITH RETURN PANEL** 14-15



HYPERION 2 SIDED GLASS-TO-GLASS HINGE DOOR AND FIXED PANEL **WITH RETURN PANEL** 16-17



CRONOS SHOWER SHIELD WALL-MOUNT HINGE CURVED SHOWER SHIELD 18-19

CRONOS TUB SHIELD WALL-MOUNT HINGE CURVED TUB SHIELD 20-21

HINGE SPECIFICATIONS 22

MICROTEK- GLASS SURFACE PROTECTION 23

BASE LINE ART

EXAMPLE OF TITAN CODE SYSTEM



TITAN : SUPPORT BAR : MODEL : RETURN PANEL : 58" APPROX. WIDTH : RETURN PANEL (FITS 36" BASE) : ULTRA CHROME : CLEAR GLASS : LEFT DOOR OPENING : OPTIONAL TOWEL BAR : FLAT HANDLE :

T | J | N | R | 58 | 36 - 99 - 40 L - D | H

SELECT YOUR DOOR OPENING DIRECTION, HANDLE STYLE AND OPTIONAL TOWEL BAR → **1** **2** **3**

HOW TO ORDER YOUR SHOWER ENCLOSURE

CHOOSE YOUR CONFIGURATION

ONE SIDED



TWO SIDED

Available with door closing against Wall or Return Panel



INDICATE FINAL DIMENSIONS

- INDICATE REQUIRED HEIGHT (B) – Standard is 79 1/4" (81 1/4" TO TOP OF SUPPORT BAR)
- FOR ONE-SIDED CONFIGURATION, INDICATE FINISHED WALL OPENING* (A)
*Finished wall opening – *Tile-to-Tile*
- FOR TWO-SIDED CONFIGURATION, INDICATE WIDTH (TO CENTER OF THRESHOLD) (D)
- FOR TWO-SIDED CONFIGURATION, INDICATE RETURN PANEL DEPTH (TO CENTER OF THRESHOLD) (C)

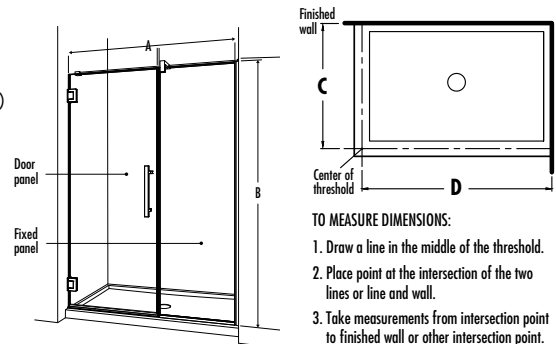

CHOOSE YOUR FINISH

- BRUSHED STAINLESS (CODE 35) OR ULTRA CHROME (CODE 99)

SELECT YOUR OPTIONS

1 IDENTIFY DOOR OPENING DIRECTION – THIS IS MANDATORY

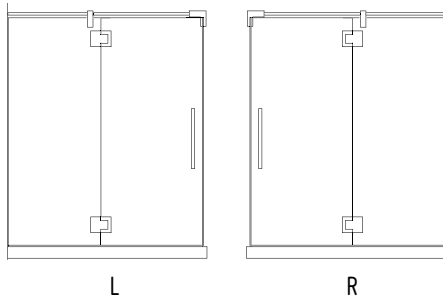

“L” (LEFT) or “R” (RIGHT) indicates where the hinges are installed on the door panel as viewed from the exterior.

TJHR5836-99-40**L**-DH
 OPENING DIRECTION

2 SELECT HANDLE STYLE – THIS IS MANDATORY

PLATED BRASS HANDLES



STAINLESS STEEL HANDLES

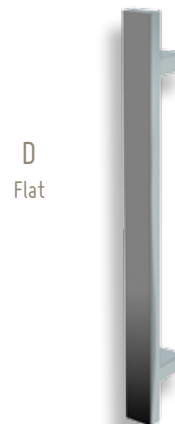

Surcharge \$144
 model C

TJNR5836-99-40**L**-D**H**
 HANDLE STYLE

3 SELECT UV-BONDED TOWEL BAR [SURCHARGE APPLIES] – THIS IS OPTIONAL

AVAILABLE FOR CERTAIN MODELS ONLY. INSTALLATION POSITION VARIES FOR EACH MODEL.
 SEE INDIVIDUAL MODEL PAGES FOR POSITION.

TJNR5836-99-40**L**-D**H**

OPTIONAL TOWEL BAR

TJNR5836-99-40**L**-D**Y**

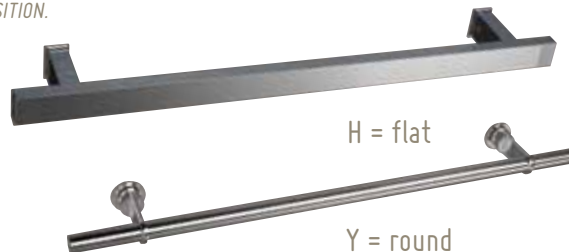

Available in two finishes:
 Polished – Surcharge \$233
 Brushed – Surcharge \$216

MICROTEK GLASS SURFACE PROTECTION
 INCLUDED AT NO CHARGE SEE INFO
 SEE INFORMATION SHEET AT THE END OF THIS SECTION FOR DETAILS.



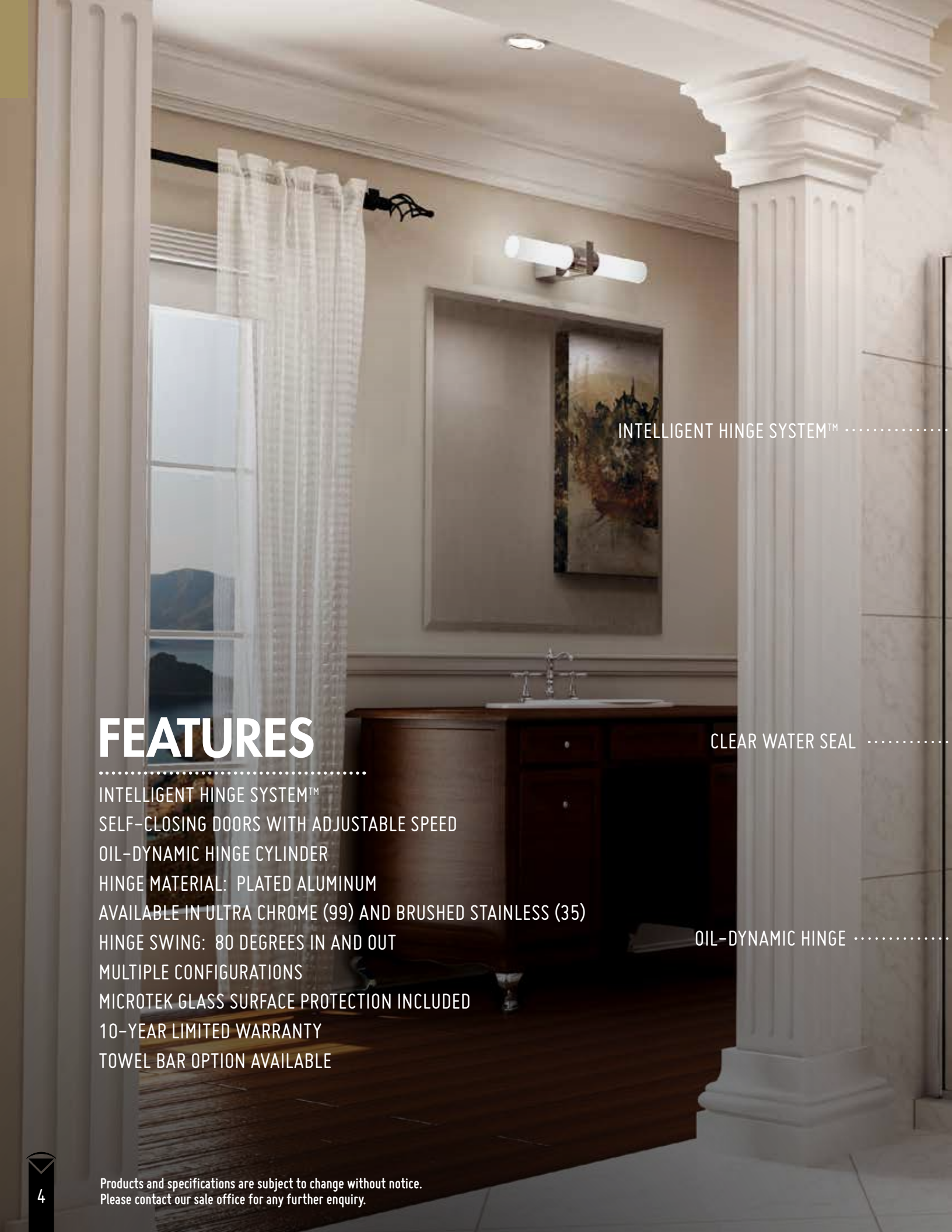

INTELLIGENT HINGE SYSTEM™

CLEAR WATER SEAL

OIL-DYNAMIC HINGE

FEATURES

- INTELLIGENT HINGE SYSTEM™
- SELF-CLOSING DOORS WITH ADJUSTABLE SPEED
- OIL-DYNAMIC HINGE CYLINDER
- HINGE MATERIAL: PLATED ALUMINUM
- AVAILABLE IN ULTRA CHROME (99) AND BRUSHED STAINLESS (35)
- HINGE SWING: 80 DEGREES IN AND OUT
- MULTIPLE CONFIGURATIONS
- MICROTEK GLASS SURFACE PROTECTION INCLUDED
- 10-YEAR LIMITED WARRANTY
- TOWEL BAR OPTION AVAILABLE

Products and specifications are subject to change without notice.
Please contact our sale office for any further enquiry.

HEADER SYSTEM FOR
ULTIMATE SUPPORT AND STYLE

TITAN

CLEAR TEMPERED GLASS: 1/2" (12 mm)

CHROME ON
ALUMINUM
ADJUSTABLE
WALL JAMB

CLEAR VERTICAL
SWEEP PROVIDES
WATER TIGHT SEAL

CHOICE OF
4 HANDLES

79" STANDARD GLASS HEIGHT
(81 1/4" TO TOP OF SUPPORT BAR)

CRONOS

WALL-MOUNT HINGE DOOR



CRONOS WALL-MOUNT HINGE DOOR

1/2" (12 mm) Tempered Clear Glass • 79" Height

CRONOS 3

33 3/4" to 34 1/4" W x 79 1/4" H • Approx. entry: 29"

MODEL	PRICE	FINISH	GLASS
TC33-99-40 ^{①-②}	\$2,087	Ultra Chrome	CLEAR
TC33-35-40 _ _	\$1,898	Brushed Stainless	CLEAR

BASE	PRICE	COLOR	SIZE
ABC36ST-18	\$616	White	36" x 36" x 3 5/8"
ABC36ST-13	\$646	Biscuit	36" x 36" x 3 5/8"
ABF3636-18	\$717	White	36" x 36" x 3"
ABF3636-13	\$753	Biscuit	36" x 36" x 3"

ABC36ST

Flanged, Center Drain

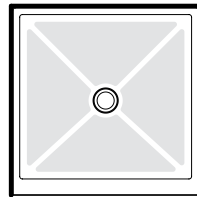

ABF3636

Quad, Center Drain

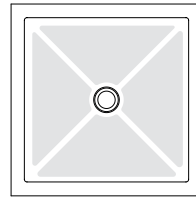

DRAIN

NO-CALK™
SHOWER BASE DRAIN*



DRAINABS-11
DRAINABS-25

ABS No-Calk 2" drain
ABS No-Calk 2" drain

\$30
\$40

Chrome
Brushed Nickel



DRAINPVC-11
DRAINPVC-25

PVC No-Calk 2" drain
PVC No-Calk 2" drain

\$30
\$40

Chrome
Brushed Nickel

*Please check local codes to ensure appropriate drain specifications

For door specifications please go to www.designashower/spec/T00

SELECT OPTIONS

Insert Code "L" or "R".

①



"L" "R"

Insert Code "A, B, C, D"
Surcharge Applies to: "C" \$144

②

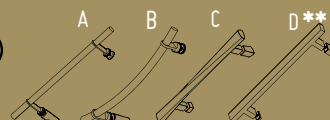

**Available in Polished Stainless (11) and Brushed Stainless (35).



Glass surface protection
See information sheet at
the end of this section.

**INCLUDED
at no charge.**

CRONOS CUBE

WALL-MOUNT HINGE DOOR WITH RETURN PANEL



CRONOS CUBE WALL-MOUNT HINGE DOOR WITH RETURN PANEL



1/2" (12 mm) Tempered Clear Glass • 79" Height

CUBE 3636

Approx. entry: 30"

36" STANDARD RETURN PANEL

33 1/2" W x 33" to 33 5/8" D x 79 1/4" H (81 1/4" to top of support bar)

MODEL	PRICE	FINISH	GLASS
TJCR3336-99-40①-②③	\$2,967	Ultra Chrome	CLEAR
TJCR3336-35-40 _ _ _	\$2,697	Brushed Stainless	CLEAR

BASE	PRICE	COLOR	SIZE
ABC36-18	\$599	White	36" x 36" x 5 1/2"
ABC36-13	\$629	Biscuit	36" x 36" x 5 1/2"
ALC36-18	\$625	White	36" x 36" x 3"
ABF3636-18	\$717	White	36" x 36" x 3"
ABF3636-13	\$753	Biscuit	36" x 36" x 3"

TOP VIEW • TJCR3336

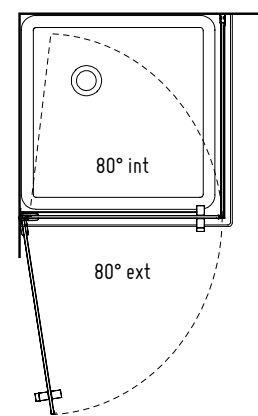

ABC

Flanged, Corner Drain

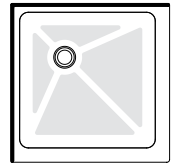

ALC

Flanged Low Profile, Covered Drain

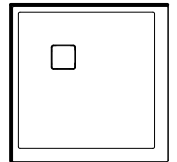

CUBE 3648

Approx. entry: 30"

48" STANDARD RETURN PANEL

33 1/2" W x 45 3/4" to 46 1/4" D x 79 1/4" H (81 1/4" to top of support bar)

MODEL	PRICE	FINISH	GLASS
TJCR3348-99-40①-②③	\$3,134	Ultra Chrome	CLEAR
TJCR3348-35-40 _ _ _	\$2,849	Brushed Stainless	CLEAR

BASE	PRICE	COLOR	SIZE
ABF3648-18	\$733	White	48" x 36" x 3"
ABF3648-13	\$771	Biscuit	48" x 36" x 3"
ABE3648-18	\$1,078	White	48" x 36" x 3"
ADF3648-18	\$882	White	48" x 36" x 2"
ABF4836-18-R2	\$733	White	48" x 36" x 3"
ABF4836-13-R2	\$771	Biscuit	48" x 36" x 3"
ABF4836-18-L2	\$733	White	48" x 36" x 3"
ABF4836-13-L2	\$771	Biscuit	48" x 36" x 3"

TOP VIEW • TJCR3348

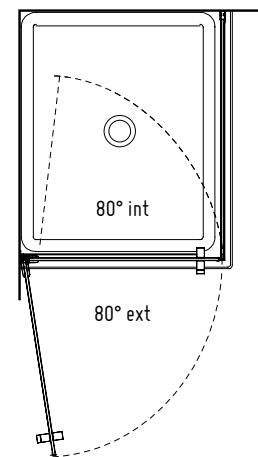

ABF

Quad, Center Drain

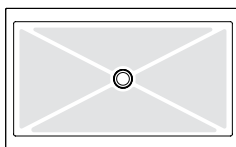

ABE

Covered Quad, Linear Style

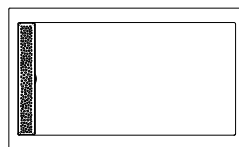

ADF

Low Profile, Covered Center Drain

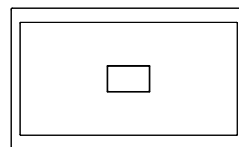

ABF-R2

Flanged, Center Drain

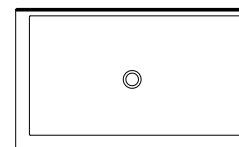

ABF-L2

Flanged, Center Drain

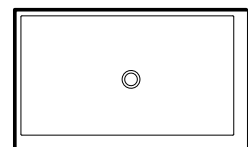

For door specifications please go to www.designashower/spec/T01

• ALL DOOR MODELS ARE SHIPPED IN 2 BOXES.

SELECT OPTIONS

Insert Code "L or R".

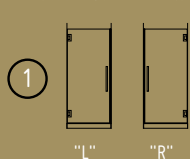

Insert Code "A, B, C, D"
Surcharge Applies to: "C" \$144

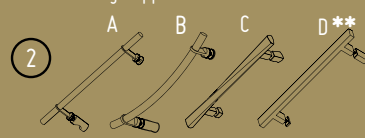

**Available in Polished Stainless (11) and Brushed Stainless (35).

Insert Code "H" (flat) or "Y" (round)
to select OPTIONAL TOWEL BAR.



Towel bar installs onto the return panel.

Available in two finishes:
CHROME - Surcharge \$233
BRUSHED - Surcharge \$216



Glass surface protection
See information sheet at
the end of this section.

INCLUDED
at no charge.

CRONOS IN-LINE

WALL-MOUNT HINGE DOOR AND FIXED PANEL



CRONOS IN-LINE WALL-MOUNT HINGE DOOR AND FIXED PANEL



1/2" (12 mm) Tempered Clear Glass • 79" Height

IN-LINE 48

45 3/4" to 46 1/4" W x 79 1/4" H (81 1/4" to top of support bar) • Approx. entry: 24"

MODEL	PRICE	FINISH	GLASS	BASE	PRICE	COLOR	SIZE
TJN45-99-40①-②	\$2,550	Ultra Chrome	CLEAR	ABF3248-18	\$712	White	48" x 32" x 3" (17)
TJN45-35-40-_-_-	\$2,427	Brushed Stainless	CLEAR	ABF3448-18	\$692	White	48" x 34" x 3" (9)
				ABF3448-13	\$730	Biscuit	48" x 34" x 3" (9)
				ABF3648-18	\$733	White	48" x 36" x 3" (10)
				ABF3648-13	\$771	Biscuit	48" x 36" x 3" (10)
				ABE3648-18	\$1,078	White	48" x 36" x 3" (25)
				ADF3648-18	\$882	White	48" x 36" x 2" (11)
				ABF4836-18-3	\$733	White	48" x 36" x 3" (36)
				ABF4836-13-3	\$771	Biscuit	48" x 36" x 3" (36)

IN-LINE 60

57 3/4" to 58 1/4" W x 79 1/4" H (81 1/4" to top of support bar) • Approx. entry: 29"

MODEL	PRICE	FINISH	GLASS	BASE	PRICE	COLOR	SIZE
TJN57-99-40①-②③	\$2,667	Ultra Chrome	CLEAR	ABF3060-18	\$770	White	60" x 30" x 3" (12)
TJN57-35-40-_-_-	\$2,425	Brushed Stainless	CLEAR	ABE3260-18	\$1,102	White	60" x 32" x 3" (24)
				ABF3260-18	\$815	White	60" x 32" x 3" (13)
				ABF3260-13	\$856	Biscuit	60" x 32" x 3" (13)
				ABF6032-18-L3	\$815	White	60" x 32" x 3" (38)
				ABF6032-13-L3	\$856	Biscuit	60" x 32" x 3" (38)
				ABF6032-18-R3	\$815	White	60" x 32" x 3" (39)
				ABF6032-13-R3	\$856	Biscuit	60" x 32" x 3" (39)
				ABF3460-18	\$844	White	60" x 34" x 3" (18)
				ABF3460-13	\$885	Biscuit	60" x 34" x 3" (18)
				ABE3660-18	\$1,122	White	60" x 36" x 3" (26)
				ADF3660-18	\$918	White	60" x 36" x 2" (20)
				ABF3660-18	\$872	White	60" x 36" x 3" (19)
				ABF3660-13	\$916	Biscuit	60" x 36" x 3" (19)
				ABF6036-18-3	\$872	White	60" x 36" x 3" (37)
				ABF6036-13-3	\$916	Biscuit	60" x 36" x 3" (37)
				ABF4260-18	\$916	White	60" x 42" x 3" (22)
				ABF4260-13	\$961	Biscuit	60" x 42" x 3" (22)
				ABF4860-18	\$1,015	White	60" x 48" x 3" (23)
				ABF4860-13	\$1,066	Biscuit	60" x 48" x 3" (23)

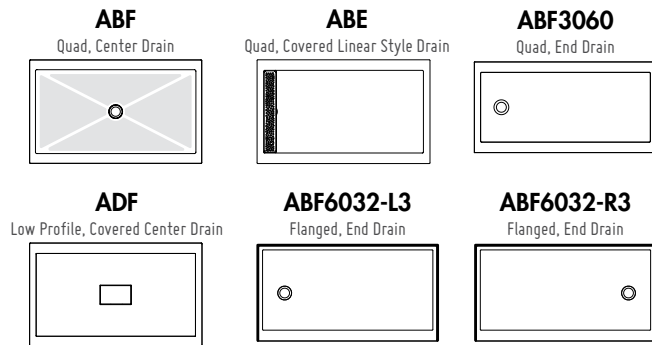

IN-LINE 72

69 3/4" to 70 1/4" W x 79 1/4" H (81 1/4" to top of support bar) • Approx. entry: 29"

MODEL	PRICE	FINISH	GLASS	BASE	PRICE	COLOR	SIZE
TJN69-99-40①-②③	\$2,896	Ultra Chrome	CLEAR	ABF3672-18	\$964	White	72" x 36" x 3" (21)
TJN69-35-40-_-_-	\$2,633	Brushed Stainless	CLEAR	ABF3672-13	\$1,013	Biscuit	72" x 36" x 3" (21)

For door specifications please go to www.designashower/spec/T02

▶ For base shapes please view the end of the section.

SELECT OPTIONS

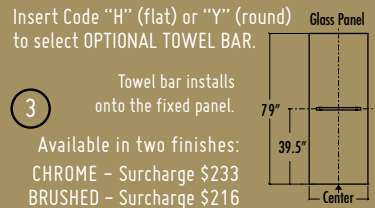
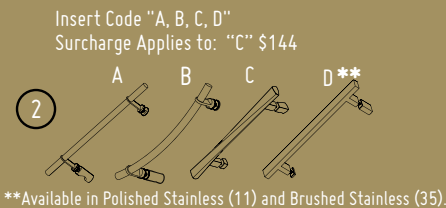
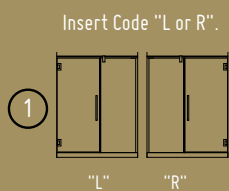

Glass surface protection See information sheet at the end of this section.
INCLUDED at no charge.

HYPERION IN-LINE

GLASS-TO-GLASS HINGE DOOR AND FIXED PANEL



HYPERION IN-LINE GLASS-TO-GLASS HINGE DOOR AND FIXED PANEL



1/2" (12 mm) Tempered Clear Glass • 79" Height

IN-LINE 48

45 5/8" to 46 3/4" W x 79 1/4" H (81 1/4" to top of support bar) • Approx. entry: 24"

MODEL	PRICE	FINISH	GLASS	BASE	PRICE	COLOR	SIZE	
TJH45-99-40①-②	\$3,281	Ultra Chrome	CLEAR	ABF3248-18	\$712	White	48" x 32" x 3"	(17)
TJH45-35-40__-	\$2,983	Brushed Stainless	CLEAR	ABF3448-18	\$692	White	48" x 34" x 3"	(9)
				ABF3448-13	\$730	Biscuit	48" x 34" x 3"	(9)
				ABF3648-18	\$733	White	48" x 36" x 3"	(10)
				ABF3648-13	\$771	Biscuit	48" x 36" x 3"	(10)
				ABE3648-18	\$1,078	White	48" x 36" x 3"	(25)
				ADF3648-18	\$882	White	48" x 36" x 2"	(11)
				ABF4836-18-3	\$733	White	48" x 36" x 3"	(36)
				ABF4836-13-3	\$771	Biscuit	48" x 36" x 3"	(36)

IN-LINE 60

57 5/8" to 58 3/4" W x 79 1/4" H (81 1/4" to top of support bar) • Approx. entry: 29"

MODEL	PRICE	FINISH	GLASS	BASE	PRICE	COLOR	SIZE	
TJH57-99-40①-②	\$3,448	Ultra Chrome	CLEAR	ABF3060-18	\$770	White	60" x 30" x 3"	(12)
TJH57-35-40__-	\$3,134	Brushed Stainless	CLEAR	ABE3260-18	\$1,102	White	60" x 32" x 3"	(24)
				ABF3260-18	\$815	White	60" x 32" x 3"	(13)
				ABF3260-13	\$856	Biscuit	60" x 32" x 3"	(13)
				ABF6032-18-L3	\$815	White	60" x 32" x 3"	(38)
				ABF6032-13-L3	\$856	Biscuit	60" x 32" x 3"	(38)
				ABF6032-18-R3	\$815	White	60" x 32" x 3"	(39)
				ABF6032-13-R3	\$856	Biscuit	60" x 32" x 3"	(39)
				ABF3460-18	\$844	White	60" x 34" x 3"	(18)
				ABF3460-13	\$885	Biscuit	60" x 34" x 3"	(18)
				ABE3660-18	\$1,122	White	60" x 36" x 3"	(26)
				ADF3660-18	\$918	White	60" x 36" x 2"	(20)
				ABF3660-18	\$872	White	60" x 36" x 3"	(19)
				ABF3660-13	\$916	Biscuit	60" x 36" x 3"	(19)
				ABF6036-18-3	\$872	White	60" x 36" x 3"	(37)
				ABF6036-13-3	\$916	Biscuit	60" x 36" x 3"	(37)
				ABF4260-18	\$916	White	60" x 42" x 3"	(22)
				ABF4260-13	\$961	Biscuit	60" x 42" x 3"	(22)
				ABF4860-18	\$1,015	White	60" x 48" x 3"	(23)
				ABF4860-13	\$1,066	Biscuit	60" x 48" x 3"	(23)

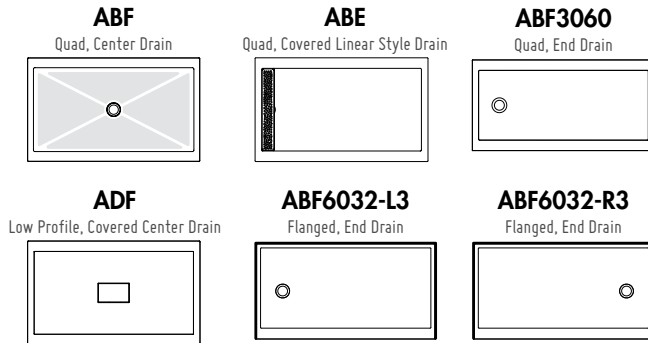

IN-LINE 72

69 5/8" to 70 3/4" W x 79 1/4" H (81 1/4" to top of support bar) • Approx. entry: 29"

MODEL	PRICE	FINISH	GLASS	BASE	PRICE	COLOR	SIZE	
TJH69-99-40①-②	\$3,721	Ultra Chrome	CLEAR	ABF3672-18	\$964	White	72" x 36" x 3"	(21)
TJH69-35-40__-	\$3,381	Brushed Stainless	CLEAR	ABF3672-13	\$1,013	Biscuit	72" x 36" x 3"	(21)

For door specifications please go to www.designashower/spec/T04

▶ For base shapes please view the end of the section.

SELECT OPTIONS

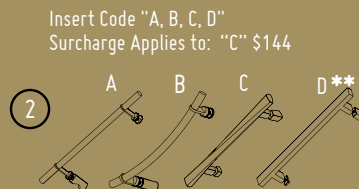
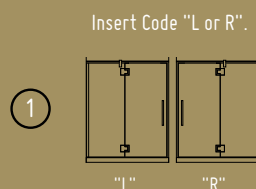

Glass surface protection
See information sheet at
the end of this section.

**INCLUDED
at no charge.**

CRONOS 2 SIDED

WALL-MOUNT HINGE DOOR
AND FIXED PANEL WITH RETURN PANEL



CRONOS 2 SIDED

WALL-MOUNT HINGE DOOR AND FIXED PANEL WITH RETURN PANEL



1/2" (12 mm) Tempered Clear Glass • 79" Height

RP You must indicate your return panel size 32", 36", 42" or 48" into the "RP" field

IN-LINE 48 WITH RETURN PANEL

MODEL	PRICE				FINISH	BASE	PRICE	COLOR	SIZE	▶
	32"	36"	42"	48"						
46" W x 79 1/4" H (81 1/4" to top of support bar) • Approx. entry: 24"										
TJNR46 <u>RP</u> -99-40①-②	\$3,803	\$3,863	\$3,924	\$3,985	Ultra Chrome	ABF3248-18	\$712	White	48" x 32" x 3"	(17)
TJNR46 __-35-40 __	\$3,450	\$3,511	\$3,571	\$3,632	Brushed Stainless	ABF3648-18	\$733	White	48" x 36" x 3"	(10)
						ABF3648-13	\$771	Biscuit	48" x 36" x 3"	(10)
						ABE3648-18	\$1,078	White	48" x 36" x 3"	(25)
						ADF3648-18	\$882	White	48" x 36" x 2"	(11)
						ABF4836-18-L2	\$733	White	48" x 36" x 3"	(54)
						ABF4836-13-L2	\$771	Biscuit	48" x 36" x 3"	(54)
						ABF4836-18-R2	\$733	White	48" x 36" x 3"	(55)
						ABF4836-13-R2	\$771	Biscuit	48" x 36" x 3"	(55)

RETURN PANELS

32" RP = 29" to 29 1/2" 36" RP = 33" to 33 1/2"
 42" RP = 39" to 39 1/2" 48" RP = 45" to 45 1/2"

IN-LINE 60 WITH RETURN PANEL

MODEL	PRICE				FINISH	BASE	PRICE	COLOR	SIZE	▶
	32"	36"	42"	48"						
58" W x 79 1/4" H (81 1/4" to top of support bar) • Approx. entry: 29"										
TJNR58 <u>RP</u> -99-40①-②③	\$3,972	\$4,032	\$4,091	\$4,149	Ultra Chrome	ABF3260-18	\$815	White	60" x 32" x 3"	(13)
TJNR58 __-35-40 __	\$3,608	\$3,662	\$3,716	\$3,770	Brushed Stainless	ABF3260-13	\$856	Biscuit	60" x 32" x 3"	(13)
						ABE3260-18	\$1,102	White	60" x 32" x 3"	(24)
						ABF3660-18	\$872	White	60" x 36" x 3"	(19)
						ABF3660-13	\$916	Biscuit	60" x 36" x 3"	(19)
						ABE3660-18	\$1,122	White	60" x 36" x 3"	(26)
						ADF3660-18	\$918	White	60" x 36" x 2"	(20)
						ABF6036-18-L2	\$872	White	60" x 36" x 3"	(56)
						ABF6036-13-L2	\$916	Biscuit	60" x 36" x 3"	(56)
						ABF6036-18-R2	\$872	White	60" x 36" x 3"	(57)
						ABF6036-13-R2	\$916	Biscuit	60" x 36" x 3"	(57)
						ABF4260-18	\$916	White	60" x 42" x 3"	(22)
						ABF4260-13	\$961	Biscuit	60" x 42" x 3"	(22)
						ABF4860-18	\$1,015	White	60" x 48" x 3"	(23)
						ABF4860-13	\$1,066	Biscuit	60" x 48" x 3"	(23)

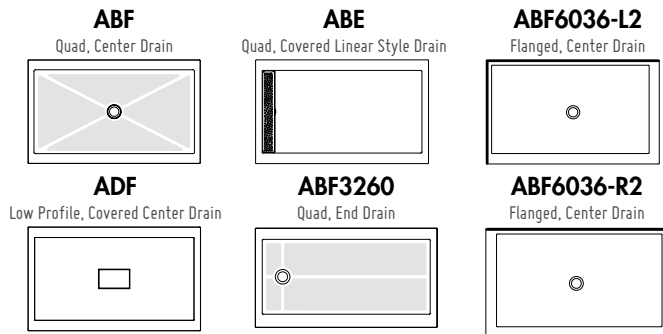

IN-LINE 72 WITH RETURN PANEL

MODEL	PRICE				FINISH	BASE	PRICE	COLOR	SIZE	▶
	32"	36"	42"	48"						
70" W x 79 1/4" H (81 1/4" to top of support bar) • Approx. entry: 29"										
TJNR70 <u>RP</u> -99-40①-②③	\$4,136	\$4,197	\$4,257	\$4,318	Ultra Chrome	ABF3672-18	\$964	White	72" x 36" x 3"	(21)
TJNR70 __-35-40 __	\$3,753	\$3,814	\$3,874	\$3,935	Brushed Stainless	ABF3672-13	\$1,013	Biscuit	72" x 36" x 3"	(21)

▶ For base shapes please view the end of the section.

• ALL DOOR MODELS ARE SHIPPED IN 3 BOXES.

For door specifications please go to www.designashower/spec/T03

SELECT OPTIONS

1 Insert Code "L or R".

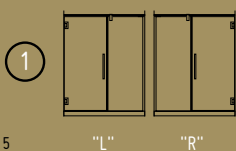

2 Insert Code "A, B, C, D" Surcharge Applies to: "C" \$144

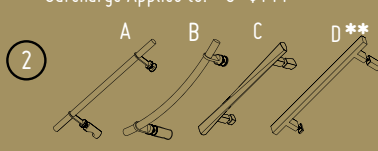

3 Insert Code "H" (flat) or "Y" (round) to select OPTIONAL TOWEL BAR.

Towel bar installs onto the fixed panel.

Available in two finishes:
 CHROME - Surcharge \$233
 BRUSHED - Surcharge \$216

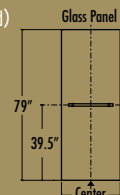

Glass surface protection See information sheet at the end of this section.

INCLUDED at no charge.

HYPERION 2 SIDED

GLASS-TO-GLASS HINGE DOOR
AND FIXED PANEL WITH RETURN PANEL



HYPERION 2 SIDED

GLASS-TO-GLASS HINGE DOOR AND FIXED PANEL WITH RETURN PANEL



1/2" (12 mm) Tempered Clear Glass • 79" Height

RP You must indicate your return panel size 32", 36", 42" or 48" into the "RP" field

IN-LINE 48 WITH RETURN PANEL

MODEL	PRICE				FINISH	BASE	PRICE	COLOR	SIZE	▶
	32"	36"	42"	48"						
45 3/4" to 46 1/4" W x 79 1/4" H (81 1/4" to top of support bar) • Approx. entry: 24"										
TJHR46 RP -99-40①-②③	\$4,203	\$4,264	\$4,324	\$4,383	Ultra Chrome	ABF3248-18	\$712	White	48" x 32" x 3"	(17)
TJHR46 __-35-40 __-__	\$3,816	\$3,876	\$3,937	\$3,995	Brushed Stainless	ABF3648-18	\$733	White	48" x 36" x 3"	(10)
						ABF3648-13	\$771	Biscuit	48" x 36" x 3"	(10)
						ABE3648-18	\$1,078	White	48" x 36" x 3"	(25)
						ADF3648-18	\$882	White	48" x 36" x 2"	(11)
						ABF4836-18-L2	\$733	White	48" x 36" x 3"	(54)
						ABF4836-13-L2	\$771	Biscuit	48" x 36" x 3"	(54)
						ABF4836-18-R2	\$733	White	48" x 36" x 3"	(55)
						ABF4836-13-R2	\$771	Biscuit	48" x 36" x 3"	(55)

RETURN PANELS

32" RP = 29 1/8" to 29 5/8" 36" RP = 33 1/8" to 33 5/8"
42" RP = 39 1/8" to 39 5/8" 48" RP = 45 1/8" to 45 5/8"

IN-LINE 60 WITH RETURN PANEL

MODEL	PRICE				FINISH	BASE	PRICE	COLOR	SIZE	▶
	32"	36"	42"	48"						
57 3/4" to 58 1/4" W x 79 1/4" H (81 1/4" to top of support bar) • Approx. entry: 29"										
TJHR58 RP -99-40①-②③	\$4,372	\$4,432	\$4,491	\$4,549	Ultra Chrome	ABF3260-18	\$815	White	60" x 32" x 3"	(13)
TJHR58 __-35-40 __-__	\$3,974	\$4,028	\$4,082	\$4,136	Brushed Stainless	ABF3260-13	\$856	Biscuit	60" x 32" x 3"	(13)
						ABE3260-18	\$1,102	White	60" x 32" x 3"	(24)
						ABF3660-18	\$872	White	60" x 36" x 3"	(19)
						ABF3660-13	\$916	Biscuit	60" x 36" x 3"	(19)
						ABE3660-18	\$1,122	White	60" x 36" x 3"	(26)
						ADF3660-18	\$918	White	60" x 36" x 2"	(20)
						ABF6036-18-L2	\$872	White	60" x 36" x 3"	(56)
						ABF6036-13-L2	\$916	Biscuit	60" x 36" x 3"	(56)
						ABF6036-18-R2	\$872	White	60" x 36" x 3"	(57)
						ABF6036-13-R2	\$916	Biscuit	60" x 36" x 3"	(57)
						ABF4260-18	\$916	White	60" x 42" x 3"	(22)
						ABF4260-13	\$961	Biscuit	60" x 42" x 3"	(22)
						ABF4860-18	\$1,015	White	60" x 48" x 3"	(23)
						ABF4860-13	\$1,066	Biscuit	60" x 48" x 3"	(23)

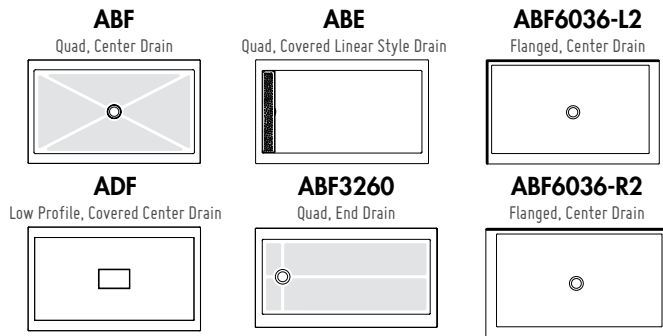

IN-LINE 72 WITH RETURN PANEL

MODEL	PRICE				FINISH	BASE	PRICE	COLOR	SIZE	▶
	32"	36"	42"	48"						
69 3/4" to 70 1/4" W x 79 1/4" H (81 1/4" to top of support bar) • Approx. entry: 29"										
TJNR70 RP -99-40①-②③	\$4,536	\$4,597	\$4,657	\$4,716	Ultra Chrome	ABF3672-18	\$964	White	72" x 36" x 3"	(21)
TJNR70 __-35-40 __-__	\$4,119	\$4,179	\$4,240	\$4,300	Brushed Stainless	ABF3672-13	\$1,013	Biscuit	72" x 36" x 3"	(21)

▶ For base shapes please view the end of the section.

• ALL DOOR MODELS ARE SHIPPED IN 3 BOXES.

For door specifications please go to www.designashower/spec/T05

SELECT OPTIONS

Insert Code "L or R".

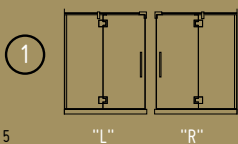

Insert Code "A, B, C, D"
Surcharge Applies to: "C" \$144

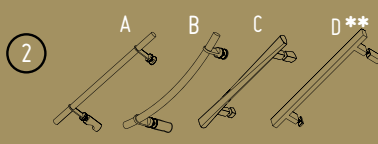

Insert Code "H" (flat) or "Y" (round)
to select OPTIONAL TOWEL BAR.

Towel bar installs onto the return panel.
Available in two finishes:
CHROME - Surcharge \$233
BRUSHED - Surcharge \$216

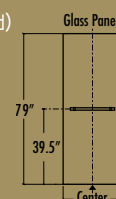

Glass surface protection
See information sheet at
the end of this section.

INCLUDED
at no charge.

CRONOS SHOWER SHIELD

WALL-MOUNT HINGE CURVED SHOWER SHIELD



CRONOS SHOWER SHIELD

WALL-MOUNT HINGE CURVED SHOWER SHIELD

TITAN

5/16" (8 mm) Tempered Clear Glass • 79" Height



CURVED SHOWER SHIELD

35" W x 6 1/2" D x 79 1/4" H • Entry opening: walk-in

MODEL	PRICE	FINISH	GLASS
TNSS35-99-40 ①	\$2,154	Ultra Chrome	CLEAR
TNSS35-35-40 _	\$2,100	Brushed Stainless	CLEAR

Fits any base 48" and larger.



DRAIN	NO-CALK™ SHOWER BASE DRAIN*	 	DRAINABS-11	ABS No-Calk 2" drain	\$30	Chrome
			DRAINABS-25	ABS No-Calk 2" drain	\$40	Brushed Nickel
DRAINPVC-11	PVC No-Calk 2" drain	\$30	Chrome			
DRAINPVC-25	PVC No-Calk 2" drain	\$40	Brushed Nickel			

*Please check local codes to ensure appropriate drain specifications

For door specifications please go to www.designashower/spec/T17

SELECT OPTIONS

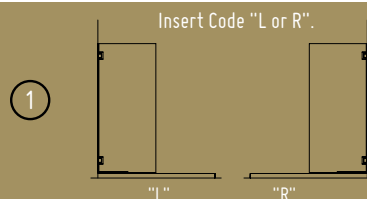

Glass surface protection
See information sheet at
the end of this section.

**INCLUDED
at no charge.**

CRONOS TUB SHIELD

WALL-MOUNT HINGE CURVED TUB SHIELD



CRONOS TUB SHIELD

WALL-MOUNT HINGE CURVED TUB SHIELD

TITAN

5/16" (8 mm) Tempered Clear Glass • 66" Height

CURVED TUB SHIELD

35" W x 6 1/2" D x 66 1/4" H • Entry opening: walk-in

MODEL	PRICE	FINISH	GLASS
TNSH35-99-40 ①	\$2,036	Ultra Chrome	CLEAR
TNSH35-35-40 _	\$1,981	Brushed Stainless	CLEAR



For door specifications please go to www.designashower/spec/T18

Insert Code "L" or "R".

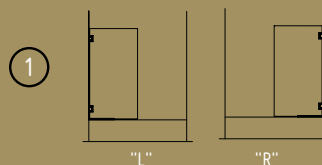

Glass surface protection
See information sheet at
the end of this section.

INCLUDED
at no charge.



GLASS-TO-GLASS HINGE

MODEL	PRICE/ea.	FINISH
HINGETGG-99-12C	\$770	Ultra Chrome
HINGETGG-35-12C	\$742	Brushed Stainless



TOP VIEW

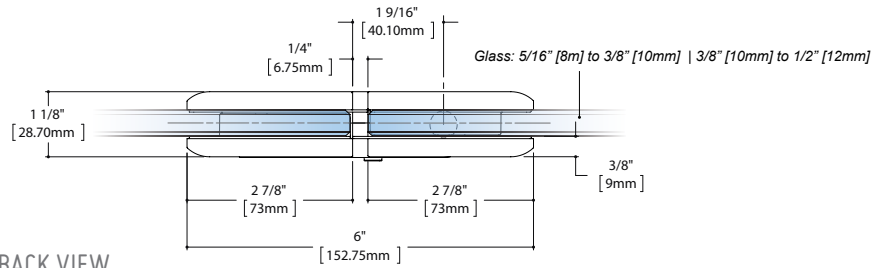

BACK VIEW

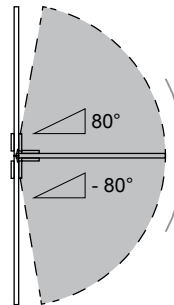
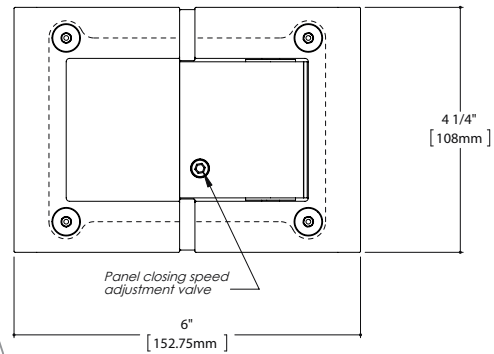

SELF CLOSING, BOTH SIDES
0°–80°

WALL-MOUNT HINGE

MODEL	PRICE/ea.	FINISH
HINGETWM-99-12C	\$513	Ultra Chrome
HINGETWM-35-12C	\$486	Brushed Stainless

MAXIMUM ADJUSTMENT OF 1/4" FOR OUT OF PLUMB DOORS



TOP VIEW

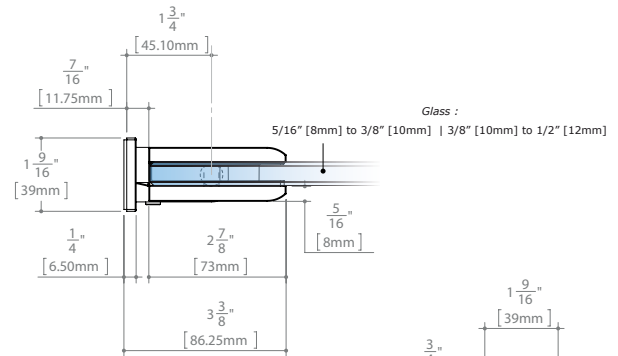

BACK VIEW

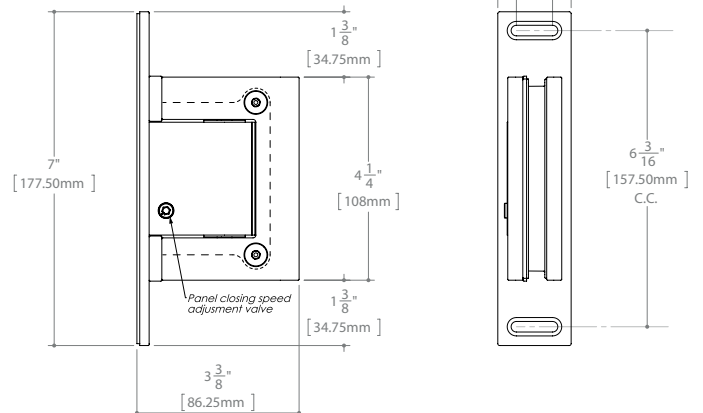

IMPORTANT
Wall-mounted hinges must be supported and fastened into a wall stud.

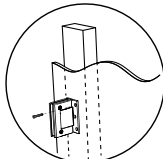

Microtek Glass Protector



Protect your shower glass and extend its life by choosing Microtek, Fleurco's unique water repellent coating. Microtek uses the latest technology to offer easy maintenance and a hygienic environment. Microtek protects your glass for up to ten years.

COMPARED WITH ORDINARY GLASS, MICROTEK:

- Resists staining from hard water deposits.
- Is easier to clean.
- Does not support the growth of bacteria.
- Eliminates the need for harsh and abrasive cleaning products.

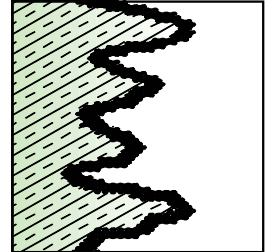

YOUR GLASS PROTECTED WITH MICROTEK

- Saves time and effort.
- Stays cleaner longer.
- Creates a more hygienic environment.



PRECAUTIONS

- Avoid using abrasive cleaners.
- Hydrofluoric and phosphoric acid can damage glass surface and should not be used.
- Do not use abrasive scouring powders or pads, highly acidic/alkaline cleaners, brushers, razor blades or other sharp objects which may scratch or harm the glass surface.

MAINTENANCE

A soft cloth is all you need to clean your protected glass. For best results, squeegee dry after each use.

DURABILITY GUIDELINES

MICROTEK IS EXPECTED TO PERFORM FOR UP TO

10 YEARS

WARRANTY

Provided the glass is maintained according to published after-care instructions and without the use of abrasive cleaning methods or highly alkaline products, FLEURCO warrants that Microtek will work for up to ten (10) years from the date of application.

