

# EVOLUTION

EXCELLENCE BY DESIGN



FLEURCO

MONACO SERIES

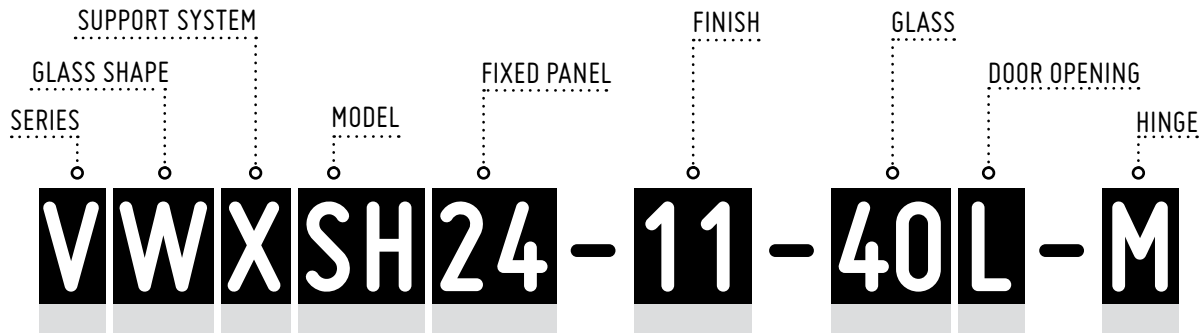

4', 5' AND 6' SERIES

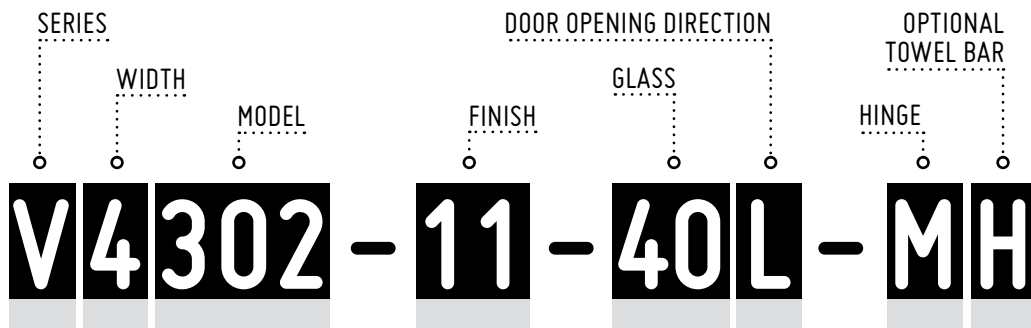

SERIES — V EVOLUTION

MONACO SERIES SUPPORT SYSTEMS

- X SUPPORT BAR SYSTEM
- G GLASS SHELF SUPPORT\*

\*Rectangular "M" and Square "T" Hinges come with SQUARE Glass Shelf Support BRACKETS.

\*Oval "Q" and Round "R" Hinges come with ROUND Glass Shelf Support BRACKETS.

MONACO SERIES MODELS

- SH TUB SHIELD
- SS SHOWER SHIELD

MONACO SERIES FIXED PANEL

FIXED PANEL WIDTH

WIDTH

- 4 4' WIDE MODELS
- 56 5' & 6' WIDE MODELS
- 6 6' WIDE MODELS

METAL FINISHES

- 11 BRIGHT CHROME
- 25 BRUSHED NICKEL
- 29 OIL-RUBBED BRONZE

GLASS

- 40 CLEAR GLASS
- 80 MIST GLASS

DOOR OPENING DIRECTION

- R RIGHT OPENING
- L LEFT OPENING

HINGES

- M RECTANGULAR
- Q OVAL
- T SQUARE
- R ROUND

TOWEL BAR

- H FLAT TOWEL BAR
- Y ROUND TOWEL BAR

11 Bright Chrome

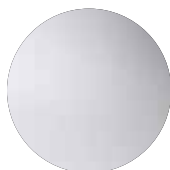

25 Brushed Nickel



29 Oil-Rubbed Bronze

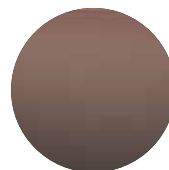

**MODEL NUMBER EXPLANATIONS** ..... 2

**EXAMPLE OF CODE SYSTEM** ..... 4

**PRODUCT OPTIONS** ..... 5

**FEATURES** ..... 6 - 7



**MONACO** SQUARE TOP TUB SHIELD WITH FIXED PANEL ..... 8 - 9



**MONACO** ROUND TOP TUB SHIELD WITH FIXED PANEL ..... 10 - 11



**SOLO** TUB SHIELD ..... 12 - 13



**MONACO** SQUARE TOP SHOWER SHIELD WITH FIXED PANEL ..... 14 - 15



**MONACO** ROUND TOP SHOWER SHIELD WITH FIXED PANEL ..... 16 - 17



**4' AND 5'** WALK-IN SHOWER SYSTEM ..... 18 - 19

**5' AND 6'** WALK-IN SHOWER SYSTEM ..... 20 - 25

**6'** WALK-IN SHOWER SYSTEM ..... 26 - 31



**ECLIPSE** CURVED GLASS WALK-IN SHOWER SYSTEM ..... 32

**MICROTEK – GLASS SURFACE PROTECTION** ..... 33 - 34

**BASE LINE ART** .....

# MONACO SERIES



GLASS SHELF SUPPORT - "G"

SUPPORT BAR SYSTEM - "X"



SELECT YOUR DOOR OPENING DIRECTION AND HINGE STYLE



\*FOR MODELS WITH GLASS SHELF SUPPORT - "G"  
 Rectangular and Square Hinges come with Square Glass Shelf Brackets.  
 Oval and Round Hinges come with Round Glass Shelf Brackets.  
*\*Available in 3/8" (10-mm) Clear Glass only.*

**VWGS**H**24**-**11**-**40L**-**M**

- EVOLUTION
- SQUARE TOP SHIELD
- GLASS SHELF SUPPORT
- TUB SHIELD
- 24" FIXED PANEL
- BRIGHT CHROME FINISH
- CLEAR GLASS
- LEFT OPENING DIRECTION
- RECTANGULAR HINGES

# 4', 5' and 6' SERIES



SELECT YOUR DOOR OPENING DIRECTION, HINGE STYLE AND OPTIONAL TOWEL BAR



**V4302**-**11**-**40L**-**T****H**

- EVOLUTION
- WIDTH - 4 FEET
- MODEL
- BRIGHT CHROME FINISH
- CLEAR GLASS
- LEFT OPENING DIRECTION
- SQUARE HINGES
- OPTIONAL FLAT TOWEL BAR (NOT SHOWN)

**1 IDENTIFY OPENING DIRECTION  
THIS IS MANDATORY**

VWXSS24-11-40**L**-T

OPENING DIRECTION

FOR MODELS WITHOUT HINGES

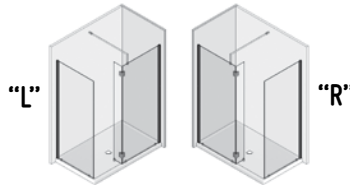

"L" (LEFT) or "R" (RIGHT) indicates the entry location as viewed from the exterior.

FOR MODELS WITH HINGES

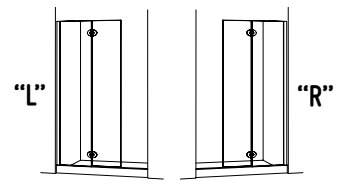

"L" (LEFT) or "R" (RIGHT) indicates where the hinges are installed on the shield panel as viewed from the exterior.

**2 SELECT SOLID BRASS HINGE STYLE  
THIS IS MANDATORY**

V4302-11-40**L**-**T**H

HINGE STYLE

**M** Rectangular



**Q** Oval



**T** Square

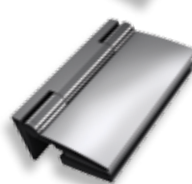
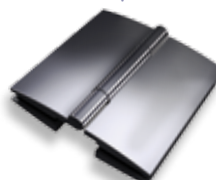

**R** Round



**3 SELECT UV BONDED TOWEL BAR  
[SURCHARGE APPLIES]**

AVAILABLE FOR CERTAIN MODELS ONLY. INSTALLATION POSITION VARIES FOR EACH MODEL. SEE INDIVIDUAL MODEL PAGES FOR POSITION.



V4302-25-40**L**-**Q****H**

OPTIONAL FLAT TOWEL BAR

Available in two finishes:  
Chrome - Surcharge \$ 233  
Brushed - Surcharge \$ 216



V4302-11-40**L**-**Q****Y**

OPTIONAL ROUND TOWEL BAR

<b>DRAIN</b> NO-CALK™ SHOWER BASE DRAIN*		DRAINABS-11	ABS No-Calk 2" drain	\$30	Chrome
		DRAINABS-25	ABS No-Calk 2" drain	\$40	Brushed Nickel
		DRAINPVC-11	PVC No-Calk 2" drain	\$30	Chrome
		DRAINPVC-11	PVC No-Calk 2" drain	\$40	Brushed Nickel

\*Please check local codes to ensure appropriate drain specifications



# FEATURES

EUROPEAN STYLE FRAMELESS DOORS

TEMPERED GLASS THICKNESS:  
3/8" (10 mm) OR 1/4" (6 mm)  
5/16" (8 mm) FOR CURVED  
GLASS PANELS

GLASS AVAILABLE IN CLEAR AND MIST\*  
*\*MIST AVAILABLE FOR CERTAIN MODELS ONLY*

75" HIGH GLASS PANELS FOR  
SHOWER MODELS

OPTIONAL MICROTEK  
GLASS SURFACE PROTECTION

MULTIPLE CONFIGURATIONS

CUSTOM SIZES AVAILABLE

10-YEAR LIMITED WARRANTY

EUROPEAN STYLE  
SUPPORT BARS

PVC SEAL FOR  
WATER RETENTION

Products and specifications are subject to change without notice.  
Please contact our sale office for any further enquiry.



4 HINGE SHAPES  
3 FINISHES

ADJUSTABLE WALL JAMBS

OPTIONAL  
TOWEL BAR

DEFLECTOR SHIELD  
TECHNOLOGY

# MONACO

SQUARE TOP TUB SHIELD WITH FIXED PANEL





# MONACO

SQUARE TOP TUB SHIELD WITH FIXED PANEL

# EVOLUTION

Available with your choice of two support systems

## MONACO SUPPORT BAR SYSTEM

58" H (59 1/2" to top of support bar)

3/8" (10 mm) Clear Tempered Glass

SUPPORT BAR SYSTEM			
MODEL	PRICE	FINISH	GLASS
VWXSH24-11-40①-②	\$1,305	Bright Chrome	CLEAR
VWXSH24-25-40 _ _	\$1,450	Brushed Nickel	CLEAR
VWXSH24-29-40 _ _	\$1,548	Oil-Rubbed Bronze	CLEAR

Support Bar System

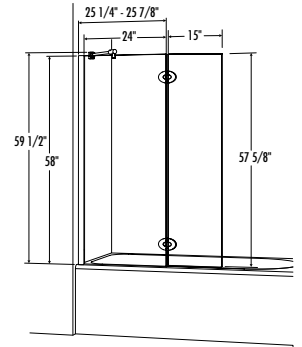

### SUPPORT BAR SYSTEM - "X"

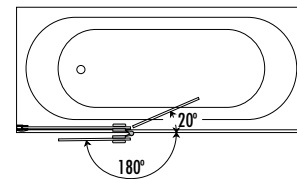

## MONACO GLASS SHELF SUPPORT

58" H

3/8" (10 mm) Clear Tempered Glass

GLASS SHELF SUPPORT			
MODEL	PRICE	FINISH	GLASS
VWGS24-11-40①-②	\$1,305	Bright Chrome	CLEAR
VWGS24-25-40 _ _	\$1,450	Brushed Nickel	CLEAR
VWGS24-29-40 _ _	\$1,548	Oil-Rubbed Bronze	CLEAR

Glass Shelf Support

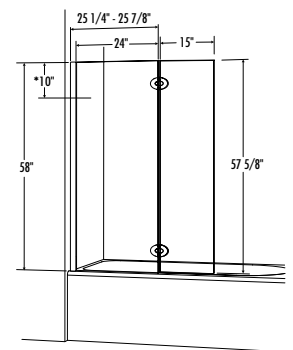

\* Position of shelf from top of glass panel

### SELECT OPTIONS

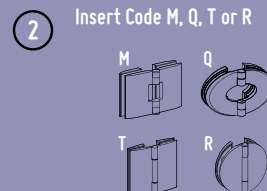
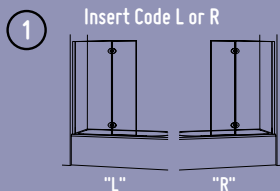

Glass surface protection  
See information sheet at  
the end of this section.

**OPTIONAL**

# MONACO

ROUND TOP TUB SHIELD WITH FIXED PANEL



Available with your choice of two support systems

## MONACO SUPPORT BAR SYSTEM

58" H (59 1/2" to top of support bar)

3/8" (10 mm) Tempered Glass			
SUPPORT BAR SYSTEM			
MODEL	PRICE	FINISH	GLASS
CLEAR TEMPERED GLASS 3/8" (10 mm)			
VXSH24-11-40①-②	\$1,305	Bright Chrome	CLEAR
VXSH24-25-40 __ __	\$1,450	Brushed Nickel	CLEAR
VXSH24-29-40 __ __	\$1,548	Oil-Rubbed Bronze	CLEAR
MIST TEMPERED GLASS 3/8" (10 mm)			
VXSH24-11-80①-②	\$1,459	Bright Chrome	MIST
VXSH24-25-80 __ __	\$1,605	Brushed Nickel	MIST
VXSH24-29-80 __ __	\$1,703	Oil-Rubbed Bronze	MIST

## MONACO GLASS SHELF SUPPORT

58" H

3/8" (10 mm) Tempered Glass			
GLASS SHELF SUPPORT*			
MODEL	PRICE	FINISH	GLASS
CLEAR TEMPERED GLASS 3/8" (10 mm)			
VGSH24-11-40①-②	\$1,305	Bright Chrome	CLEAR
VGSH24-25-40 __ __	\$1,450	Brushed Nickel	CLEAR
VGSH24-29-40 __ __	\$1,548	Oil-Rubbed Bronze	CLEAR
MIST TEMPERED GLASS 3/8" (10 mm)			
VGSH24-11-80①-②	\$1,459	Bright Chrome	MIST
VGSH24-25-80 __ __	\$1,605	Brushed Nickel	MIST
VGSH24-29-80 __ __	\$1,703	Oil-Rubbed Bronze	MIST

\*Glass Shelves are available in 3/8" (10 mm) Clear Glass only.

## MONACO SUPPORT BAR SYSTEM

58" H (59 1/2" to top of support bar)

1/4" (6 mm) Tempered Glass			
SUPPORT BAR SYSTEM			
MODEL	PRICE	FINISH	GLASS
CLEAR TEMPERED GLASS 3/8" (10 mm)			
VSH24-11-40①-②	\$939	Bright Chrome	CLEAR
VSH24-25-40 __ __	\$1,085	Brushed Nickel	CLEAR
VSH24-29-40 __ __	\$1,183	Oil-Rubbed Bronze	CLEAR
<i>The above models are only available with the support bar system</i>			
MIST TEMPERED GLASS 3/8" (10 mm)			
VSH24-11-80①-②	\$1,200	Bright Chrome	MIST
VSH24-25-80 __ __	\$1,346	Brushed Nickel	MIST
VSH24-29-80 __ __	\$1,445	Oil-Rubbed Bronze	MIST
<i>The above models are only available with the support bar system</i>			

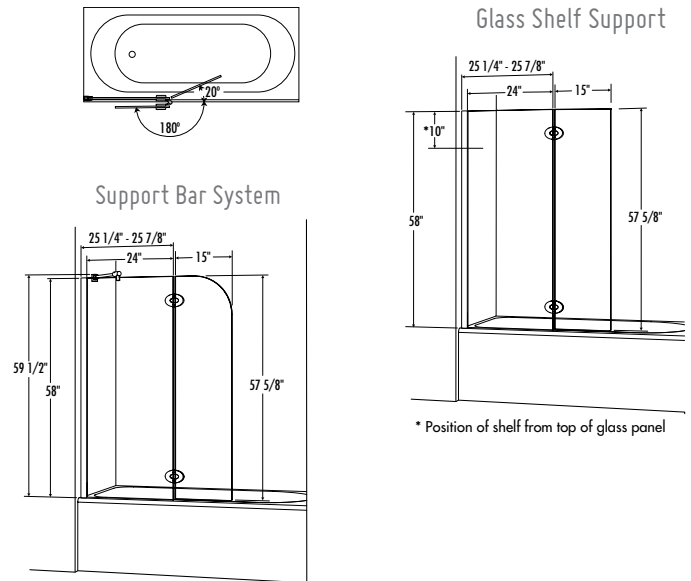

SUPPORT BAR SYSTEM - "X"



MIST GLASS

## SELECT OPTIONS

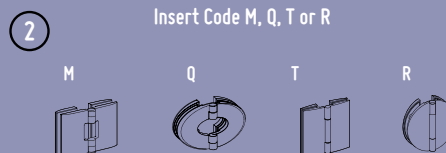
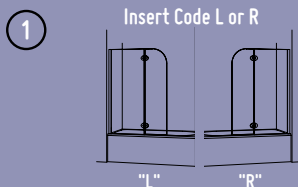

Glass surface protection  
See information sheet at  
the end of this section.

**OPTIONAL**



**SOLO** TUB SHIELD



**SOLO** 29" W x 63" H

MODEL	PRICE	FINISH	GLASS
<b>3/8" (10 mm) CLEAR TEMPERED GLASS</b>			
VXT029-11-40①-②	\$886	Bright Chrome	CLEAR
VXT029-25-40 _ _	\$952	Brushed Nickel	CLEAR
VXT029-29-40 _ _	\$1,037	Oil-Rubbed Bronze	CLEAR

MODEL	PRICE	FINISH	GLASS
<b>1/4" (6 mm) CLEAR TEMPERED GLASS</b>			
VT029-11-40①-②	\$723	Bright Chrome	CLEAR
VT029-25-40 _ _	\$790	Brushed Nickel	CLEAR
VT029-29-40 _ _	\$875	Oil-Rubbed Bronze	CLEAR

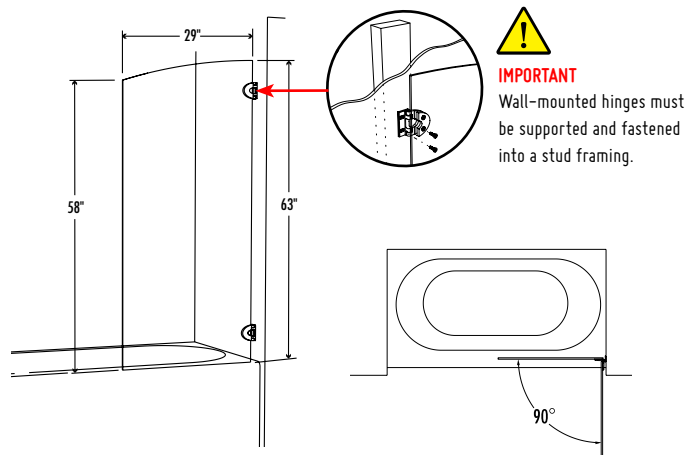

**SELECT OPTIONS**

① Insert Code L or R

"L" "R"

② Insert Code M, Q, T or R

M Q  
T R



Glass surface protection  
See information sheet at  
the end of this section.

**OPTIONAL**

# MONACO

SQUARE TOP SHOWER SHIELD WITH FIXED PANEL





# MONACO SQUARE TOP SHOWER SHIELD WITH FIXED PANEL

Available with your choice of two support systems

## MONACO SUPPORT BAR SYSTEM

75" H (76 1/2" to top of support bar)

3/8" (10 mm) Clear Tempered Glass

SUPPORT BAR SYSTEM			
MODEL	PRICE	FINISH	GLASS
VWXSS24-11-40①-②	\$1,379	Bright Chrome	CLEAR
VWXSS24-25-40 _ _	\$1,502	Brushed Nickel	CLEAR
VWXSS24-29-40 _ _	\$1,623	Oil-Rubbed Bronze	CLEAR

BASE	PRICE	COLOR	SIZE	
ABF3642-18	\$714	White	42" x 36" x 3"	(8)
ABF3642-13	\$751	Biscuit	42" x 36" x 3"	(8)

\*Not compatible with alcove configurations.

ABF3448-18	\$692	White	48" x 34" x 3"	(9)
ABF3448-13	\$730	Biscuit	48" x 34" x 3"	(9)
ABF3648-18	\$733	White	48" x 36" x 3"	(10)
ABF3648-13	\$771	Biscuit	48" x 36" x 3"	(10)
ABF3260-18	\$815	White	60" x 32" x 3"	(13)
ABF3260-13	\$856	Biscuit	60" x 32" x 3"	(13)
ABF3460-18	\$844	White	60" x 34" x 3"	(18)
ABF3460-13	\$885	Biscuit	60" x 34" x 3"	(18)
ABF3660-18	\$872	White	60" x 36" x 3"	(19)
ABF3660-13	\$916	Biscuit	60" x 36" x 3"	(19)
ABF4260-18	\$916	White	60" x 42" x 3"	(22)
ABF4260-13	\$961	Biscuit	60" x 42" x 3"	(22)
ABF4860-18	\$1,015	White	60" x 48" x 3"	(23)
ABF4860-13	\$1,066	Biscuit	60" x 48" x 3"	(23)

## MONACO GLASS SHELF SUPPORT

75" H

3/8" (10 mm) Clear Tempered Glass

GLASS SHELF SUPPORT			
MODEL	PRICE	FINISH	GLASS
VWGSS24-11-40①-②	\$1,379	Bright Chrome	CLEAR
VWGSS24-25-40 _ _	\$1,502	Brushed Nickel	CLEAR
VWGSS24-29-40 _ _	\$1,623	Oil-Rubbed Bronze	CLEAR

BASE	PRICE	COLOR	SIZE	
ABF3642-18	\$714	White	42" x 36" x 3"	(8)
ABF3642-13	\$751	Biscuit	42" x 36" x 3"	(8)

\*Not compatible with alcove configurations.

ABF3448-18	\$692	White	48" x 34" x 3"	(9)
ABF3448-13	\$730	Biscuit	48" x 34" x 3"	(9)
ABF3648-18	\$733	White	48" x 36" x 3"	(10)
ABF3648-13	\$771	Biscuit	48" x 36" x 3"	(10)
ABF3260-18	\$815	White	60" x 32" x 3"	(13)
ABF3260-13	\$856	Biscuit	60" x 32" x 3"	(13)
ABF3460-18	\$844	White	60" x 34" x 3"	(18)
ABF3460-13	\$885	Biscuit	60" x 34" x 3"	(18)
ABF3660-18	\$872	White	60" x 36" x 3"	(19)
ABF3660-13	\$916	Biscuit	60" x 36" x 3"	(19)
ABF4260-18	\$916	White	60" x 42" x 3"	(22)
ABF4260-13	\$961	Biscuit	60" x 42" x 3"	(22)
ABF4860-18	\$1,015	White	60" x 48" x 3"	(23)
ABF4860-13	\$1,066	Biscuit	60" x 48" x 3"	(23)

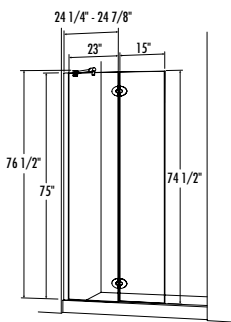

Support Bar System

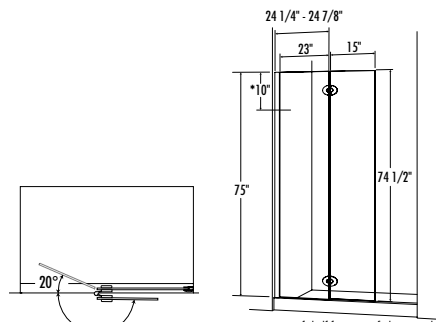

Glass Shelf Support

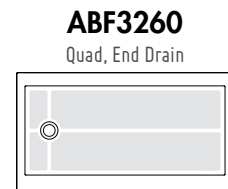

ABF3260

Quad, End Drain

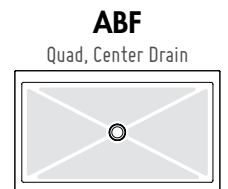

ABF

Quad, Center Drain

SUPPORT BAR SYSTEM - "X"



DRAIN NO-CALK™ SHOWER BASE DRAIN*	ABS No-Calk 2" drain		PVC No-Calk 2" drain	
	DRAINABS-11	\$30	DRAINPVC-11	\$30
DRAINABS-25	\$40	DRAINPVC-11	\$40	Brushed Nickel
DRAINABS-11	\$30	DRAINPVC-11	\$40	Chrome
DRAINPVC-11	\$40	DRAINPVC-11	\$40	Brushed Nickel

\*Please check local codes to ensure appropriate drain specifications

For base shapes please view the end of the section.

## SELECT OPTIONS

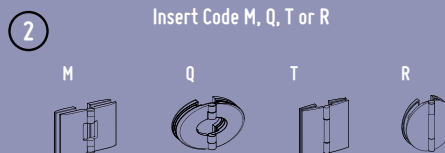
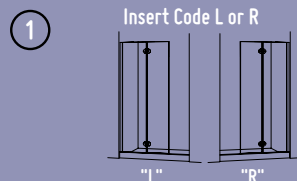

Glass surface protection  
See information sheet at  
the end of this section.

OPTIONAL

# MONACO

ROUND TOP SHOWER SHIELD WITH FIXED PANEL



# MONACO ROUND TOP SHOWER SHIELD WITH FIXED PANEL



Available with your choice of two support systems

## MONACO SUPPORT BAR SYSTEM

75" H (76 1/2" to top of support bar)

SUPPORT BAR SYSTEM			
MODEL	PRICE	FINISH	GLASS
<b>CLEAR TEMPERED GLASS 3/8" (10 mm)</b>			
VXSS24-11-40 <sup>①-②</sup>	\$1,379	Bright Chrome	CLEAR
VXSS24-25-40 _ _	\$1,502	Brushed Nickel	CLEAR
VXSS24-29-40 _ _	\$1,623	Oil-Rubbed Bronze	CLEAR
<b>MIST TEMPERED GLASS 3/8" (10 mm)</b>			
VXSS24-11-80 <sup>①-②</sup>	\$1,506	Bright Chrome	MIST
VXSS24-25-80 _ _	\$1,629	Brushed Nickel	MIST
VXSS24-29-80 _ _	\$1,750	Oil-Rubbed Bronze	MIST

  

BASE	PRICE	COLOR	SIZE
ABF3642-18	\$714	White	42" x 36" x 3" (8)
ABF3642-13	\$751	Biscuit	42" x 36" x 3" (8)
<i>*Not compatible with alcove configurations.</i>			
ABF3448-18	\$692	White	48" x 34" x 3" (9)
ABF3448-13	\$730	Biscuit	48" x 34" x 3" (9)
ABF3648-18	\$733	White	48" x 36" x 3" (10)
ABF3648-13	\$771	Biscuit	48" x 36" x 3" (10)
ABF3260-18	\$815	White	60" x 32" x 3" (13)
ABF3260-13	\$856	Biscuit	60" x 32" x 3" (13)
ABF3460-18	\$844	White	60" x 34" x 3" (18)
ABF3460-13	\$885	Biscuit	60" x 34" x 3" (18)
ABF3660-18	\$872	White	60" x 36" x 3" (19)
ABF3660-13	\$916	Biscuit	60" x 36" x 3" (19)
ABF4260-18	\$916	White	60" x 42" x 3" (22)
ABF4260-13	\$961	Biscuit	60" x 42" x 3" (22)
ABF4860-18	\$1,015	White	60" x 48" x 3" (23)
ABF4860-13	\$1,066	Biscuit	60" x 48" x 3" (23)

Support Bar System

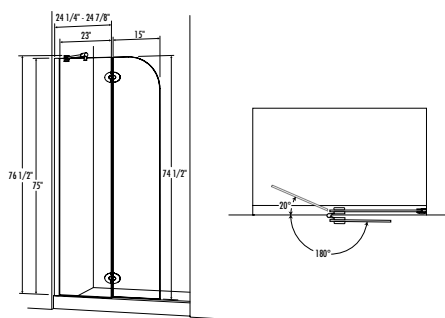

Glass Shelf Support

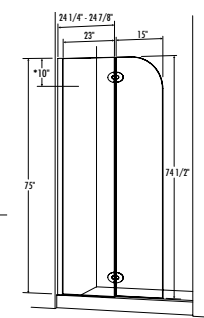

## MONACO GLASS SHELF SUPPORT

75" H

GLASS SHELF SUPPORT*			
MODEL	PRICE	FINISH	GLASS
<b>CLEAR TEMPERED GLASS 3/8" (10 mm)</b>			
VGSS24-11-40 <sup>①-②</sup>	\$1,379	Bright Chrome	CLEAR
VGSS24-25-40 _ _	\$1,502	Brushed Nickel	CLEAR
VGSS24-29-40 _ _	\$1,623	Oil-Rubbed Bronze	CLEAR
<b>MIST TEMPERED GLASS 3/8" (10 mm)</b>			
VGSS24-11-80 <sup>①-②</sup>	\$1,506	Bright Chrome	MIST
VGSS24-25-80 _ _	\$1,629	Brushed Nickel	MIST
VGSS24-29-80 _ _	\$1,750	Oil-Rubbed Bronze	MIST

*\*Glass Shelves are available in 3/8" (10 mm) Clear Glass only.*

BASE	PRICE	COLOR	SIZE
ABF3642-18	\$714	White	42" x 36" x 3" (8)
ABF3642-13	\$751	Biscuit	42" x 36" x 3" (8)
<i>*Not compatible with alcove configurations.</i>			
ABF3448-18	\$692	White	48" x 34" x 3" (9)
ABF3448-13	\$730	Biscuit	48" x 34" x 3" (9)
ABF3648-18	\$733	White	48" x 36" x 3" (10)
ABF3648-13	\$771	Biscuit	48" x 36" x 3" (10)
ABF3260-18	\$815	White	60" x 32" x 3" (13)
ABF3260-13	\$856	Biscuit	60" x 32" x 3" (13)
ABF3460-18	\$844	White	60" x 34" x 3" (18)
ABF3460-13	\$885	Biscuit	60" x 34" x 3" (18)
ABF3660-18	\$872	White	60" x 36" x 3" (19)
ABF3660-13	\$916	Biscuit	60" x 36" x 3" (19)
ABF4260-18	\$916	White	60" x 42" x 3" (22)
ABF4260-13	\$961	Biscuit	60" x 42" x 3" (22)
ABF4860-18	\$1,015	White	60" x 48" x 3" (23)
ABF4860-13	\$1,066	Biscuit	60" x 48" x 3" (23)

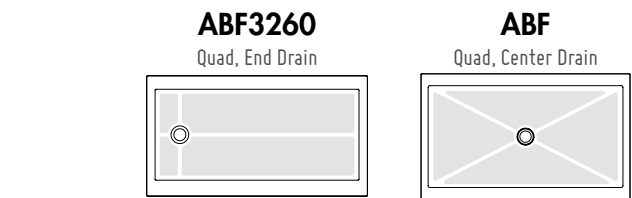

For base shapes please view the end of the section.

## SELECT OPTIONS

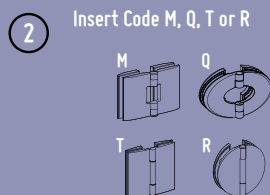
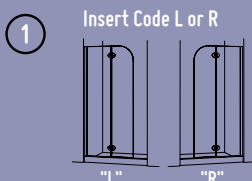

**DRAIN**  
NO-CALK™  
SHOWER BASE DRAIN\*  
SEE PAGE 5

**Microtek**  
by Fleurco

Glass surface protection  
See information sheet at  
the end of this section.

**OPTIONAL**



# 4' AND 5' WALK-IN SHOWER SYSTEM



# 4' AND 5' 4' AND 5' WALK-IN SHOWER SYSTEM

3/8" (10 mm) Clear Tempered Glass • 75" H (82 3/16" to top of support bar)

ROUND TOP	SQUARE TOP	DIMENSIONS	ROUND MODEL	SQUARE MODEL	PRICE	FINISH	GLASS
			V4301-11-40 ①-②	VW4301-11-40 ①-②	\$1,263	Bright Chrome	CLEAR
			V4301-25-40 _ _	VW4301-25-40 _ _	\$1,383	Brushed Nickel	CLEAR
			V4301-29-40 _ _	VW4301-29-40 _ _	\$1,489	Oil-Rubbed Bronze	CLEAR
			V4302-11-40 ①-②③	VW4302-11-40 ①-②③	\$1,700	Bright Chrome	CLEAR
			V4302-25-40 _ _ _	VW4302-25-40 _ _ _	\$1,819	Brushed Nickel	CLEAR
			V4302-29-40 _ _ _	VW4302-29-40 _ _ _	\$1,925	Oil-Rubbed Bronze	CLEAR

Shown with optional Towel Bar

BASE	PRICE	COLOR	SIZE
ABF3642-18	\$714	White	42" x 36" x 3" (8)
ABF3642-13	\$751	Biscuit	42" x 36" x 3" (8)
*Not compatible with alcove configurations or with return panel.			
ABF3648-18	\$733	White	48" x 36" x 3" (10)
ABF3648-13	\$771	Biscuit	48" x 36" x 3" (10)
ABF3260-18	\$815	White	60" x 32" x 3" (13)
ABF3260-13	\$856	Biscuit	60" x 32" x 3" (13)
ABF3660-18	\$872	White	60" x 36" x 3" (19)
ABF3660-13	\$916	Biscuit	60" x 36" x 3" (19)

## ABF3260

Quad, End Drain

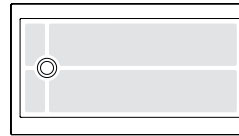

## ABF

Quad, Center Drain

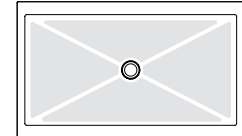

ROUND TOP	SQUARE TOP	DIMENSIONS	ROUND MODEL	SQUARE MODEL	PRICE	FINISH	GLASS
			V4304-11-40 ①-②③	VW4304-11-40 ①-②③	\$1,848	Bright Chrome	CLEAR
			V4304-25-40 _ _ _	VW4304-25-40 _ _ _	\$1,981	Brushed Nickel	CLEAR
			V4304-29-40 _ _ _	VW4304-29-40 _ _ _	\$2,073	Oil-Rubbed Bronze	CLEAR

BASE	PRICE	COLOR	SIZE
ABF3642-18	\$714	White	42" x 36" x 3" (8)
ABF3642-13	\$751	Biscuit	42" x 36" x 3" (8)
Above base is compatible with a 3 sided configuration only.			
ABF3648-18	\$733	White	48" x 36" x 3" (10)
ABF3648-13	\$771	Biscuit	48" x 36" x 3" (10)
ABF3660-18	\$872	White	60" x 36" x 3" (19)
ABF3660-13	\$916	Biscuit	60" x 36" x 3" (19)

### \*GLASS SHELF SUPPORT

- RECTANGULAR AND SQUARE HINGES COME WITH SQUARE BRACKETS.
- OVAL AND ROUND HINGES COME WITH ROUND BRACKETS.

GLASS SHELF WITH ROUND BRACKET

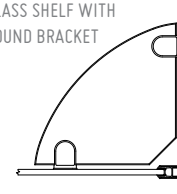

GLASS SHELF WITH SQUARE BRACKET

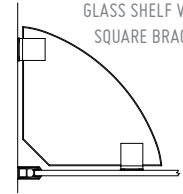

▶ For base shapes please view the end of the section.

DRAIN	NO-CALK™ SHOWER BASE DRAIN*	MODEL	DESCRIPTION	PRICE	FINISH
		DRAINABS-11	ABS No-Calk 2" drain	\$30	Chrome
		DRAINABS-25	ABS No-Calk 2" drain	\$40	Brushed Nickel
		DRAINPVC-11	PVC No-Calk 2" drain	\$30	Chrome
		DRAINPVC-11	PVC No-Calk 2" drain	\$40	Brushed Nickel

\*Please check local codes to ensure appropriate drain specifications

- ADDITIONAL RETURN PANEL SIZES ARE AVAILABLE.
- CONTACT CUSTOMER SERVICE FOR DETAILS.

## SELECT OPTIONS

1 Insert Code L or R

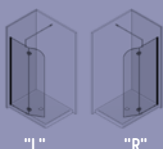

2 Insert Code M, Q, T or R

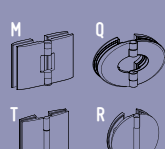

3 Insert Code H (flat) or Y (round) to select OPTIONAL TOWEL BAR

Towel Bar installs onto a Return Panel

Available in two finishes:  
CHROME - Surcharge \$233  
BRUSHED - Surcharge \$216

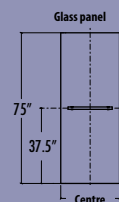

Glass surface protection  
See information sheet at the end of this section.

OPTIONAL

# 5' AND 6' WALK-IN SHOWER SYSTEM





# 5' AND 6' 5" AND 6" WALK-IN SHOWER SYSTEM

3/8" (10 mm) Clear Tempered Glass • 75" H (82 3/16" to top of support bar)

ROUND TOP	SQUARE TOP	DIMENSIONS	ROUND MODEL	SQUARE MODEL	PRICE	FINISH	GLASS
			V56304-11-40 ①-②③	VW56304-11-40 ①-②③	\$1,937	Bright Chrome	CLEAR
			V56304-25-40 _ _ _	VW56304-25-40 _ _ _	\$2,080	Brushed Nickel	CLEAR
			V56304-29-40 _ _ _	VW56304-29-40 _ _ _	\$2,236	Oil-Rubbed Bronze	CLEAR
			V56305-11-40 ①-②③	VW56305-11-40 ①-②③	\$2,446	Bright Chrome	CLEAR
			V56305-25-40 _ _ _	VW56305-25-40 _ _ _	\$2,601	Brushed Nickel	CLEAR
			V56305-29-40 _ _ _	VW56305-29-40 _ _ _	\$2,793	Oil-Rubbed Bronze	CLEAR

*Shown with optional Towel Bar*

BASE	PRICE	COLOR	SIZE
ABF3660-18	\$872	White	60" x 36" x 3" (19)
ABF3660-13	\$916	Biscuit	60" x 36" x 3" (19)
ABF3672-18	\$964	White	72" x 36" x 3" (21)
ABF3672-13	\$1,013	Biscuit	72" x 36" x 3" (21)

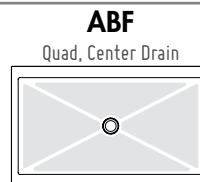

ROUND TOP	SQUARE TOP	DIMENSIONS	ROUND MODEL	SQUARE MODEL	PRICE	FINISH	GLASS
			V56301-11-40 ①-②	VW56301-11-40 ①-②	\$1,299	Bright Chrome	CLEAR
			V56301-25-40 _ _	VW56301-25-40 _ _	\$1,407	Brushed Nickel	CLEAR
			V56301-29-40 _ _	VW56301-29-40 _ _	\$1,515	Oil-Rubbed Bronze	CLEAR
			V56302-11-40 ①-②③	VW56302-11-40 ①-②③	\$1,767	Bright Chrome	CLEAR
			V56302-25-40 _ _ _	VW56302-25-40 _ _ _	\$1,874	Brushed Nickel	CLEAR
			V56302-29-40 _ _ _	VW56302-29-40 _ _ _	\$2,019	Oil-Rubbed Bronze	CLEAR

*Shown with optional Towel Bar*

BASE	PRICE	COLOR	SIZE
ABF3260-18	\$815	White	60" x 32" x 3" (13)
ABF3260-13	\$856	Biscuit	60" x 32" x 3" (13)
*Above base is compatible with models V56301 and VW56301			
ABF3660-18	\$872	White	60" x 36" x 3" (19)
ABF3660-13	\$916	Biscuit	60" x 36" x 3" (19)
ABF3672-18	\$964	White	72" x 36" x 3" (21)
ABF3672-13	\$1,013	Biscuit	72" x 36" x 3" (21)

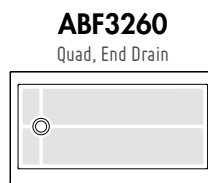

CONTINUED ON NEXT PAGE

DRAIN	NO-CALK™ SHOWER BASE DRAIN*	Model	Description	Price	Finish
	DRAINABS-11	ABS No-Calk 2" drain	\$30	Chrome	
	DRAINABS-25	ABS No-Calk 2" drain	\$40	Brushed Nickel	
	DRAINPVC-11	PVC No-Calk 2" drain	\$30	Chrome	
	DRAINPVC-11	PVC No-Calk 2" drain	\$40	Brushed Nickel	

\*Please check local codes to ensure appropriate drain specifications

For base shapes please view the end of the section.

- ADDITIONAL RETURN PANEL SIZES ARE AVAILABLE.
- CONTACT CUSTOMER SERVICE FOR DETAILS.

## SELECT OPTIONS

1 Insert Code L or R

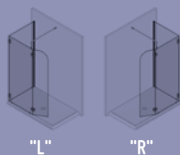

2 Insert Code M, Q, T or R

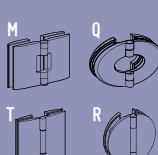

3 Insert Code H (flat) or Y (round) to select OPTIONAL TOWEL BAR

Towel Bar installs onto a return panel

Available in two finishes:  
CHROME - Surcharge \$233  
BRUSHED - Surcharge \$216

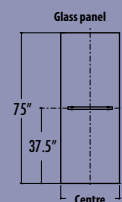

Glass surface protection See information sheet at the end of this section.

OPTIONAL



# 5' AND 6' WALK-IN SHOWER SYSTEM



# 5' AND 6' 5' AND 6' WALK-IN SHOWER SYSTEM (CONT'D)

**3/8" (10 mm) Clear Tempered Glass • 75" H (82 3/16" to top of support bar)**

DIMENSIONS		MODEL	PRICE	FINISH	GLASS
		V56310-11-40 ①	\$818	Bright Chrome	CLEAR
		V56310-25-40 _	\$864	Brushed Nickel	CLEAR
		V56310-29-40 _	\$958	Oil-Rubbed Bronze	CLEAR
<p><i>Shown with optional Towel Bar</i></p>		V56312-11-40 ①-③	\$1,282	Bright Chrome	CLEAR
		V56312-25-40 _ _	\$1,330	Brushed Nickel	CLEAR
		V56312-29-40 _ _	\$1,430	Oil-Rubbed Bronze	CLEAR
<p><i>Shown with optional Towel Bar</i></p>		V6310-11-40 ①-③	\$1,336	Bright Chrome	CLEAR
		V6310-25-40 _ _	\$1,383	Brushed Nickel	CLEAR
		V6310-29-40 _ _	\$1,478	Oil-Rubbed Bronze	CLEAR

BASE	PRICE	COLOR	SIZE	
ABF3642-18	\$714	White	42" x 36" x 3" (8)	
ABF3642-13	\$751	Biscuit	42" x 36" x 3" (8)	
*Not compatible with alcove configurations or with return panel.				
ABF3648-18	\$733	White	48" x 36" x 3" (10)	
ABF3648-13	\$771	Biscuit	48" x 36" x 3" (10)	
Above base is compatible with models V56310				
ABF3260-18	\$815	White	60" x 32" x 3" (13)	
ABF3260-13	\$856	Biscuit	60" x 32" x 3" (13)	
ABF3660-18	\$872	White	60" x 36" x 3" (19)	
ABF3660-13	\$916	Biscuit	60" x 36" x 3" (19)	
ABF3672-18	\$964	White	72" x 36" x 3" (21)	
ABF3672-13	\$1,013	Biscuit	72" x 36" x 3" (21)	

CONTINUED ON NEXT PAGE

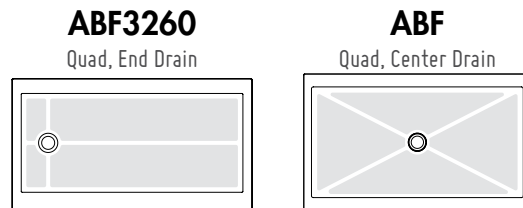

DRAIN NO-CALK™ SHOWER BASE DRAIN*	DRAINABS-11		ABS No-Calk 2" drain		Chrome	
		DRAINABS-25	ABS No-Calk 2" drain	\$30	Brushed Nickel	
	DRAINPVC-11	PVC No-Calk 2" drain	\$30	Chrome		
	DRAINPVC-11	PVC No-Calk 2" drain	\$40	Brushed Nickel		

\*Please check local codes to ensure appropriate drain specifications

For base shapes please view the end of the section.

- ADDITIONAL RETURN PANEL SIZES ARE AVAILABLE.
- CONTACT CUSTOMER SERVICE FOR DETAILS.

## SELECT OPTIONS

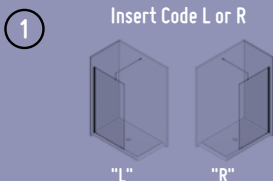

③ Insert Code H (flat) or Y (round) to select OPTIONAL TOWEL BAR

Towel Bar installs onto a return panel

Available in two finishes:  
 CHROME - Surcharge \$233  
 BRUSHED - Surcharge \$216

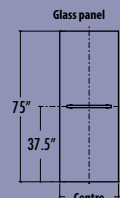

Glass surface protection  
See information sheet at the end of this section.

OPTIONAL

# 5' AND 6' WALK-IN SHOWER SYSTEM





# 5' AND 6' 5' AND 6' WALK-IN SHOWER SYSTEM (CONT'D)

**3/8" (10 mm) Clear Tempered Glass • 75" H (82 3/16" to top of support bar)**

DIMENSIONS		MODEL	PRICE	FINISH	GLASS
		V56307-11-40①-③	\$1,777	Bright Chrome	CLEAR
		V56307-25-40 _ _	\$1,908	Brushed Nickel	CLEAR
		V56307-29-40 _ _	\$2,052	Oil-Rubbed Bronze	CLEAR
		V56308-11-40①-③	\$2,256	Bright Chrome	CLEAR
		V56308-25-40 _ _	\$2,387	Brushed Nickel	CLEAR
		V56308-29-40 _ _	\$2,571	Oil-Rubbed Bronze	CLEAR

BASE	PRICE	COLOR	SIZE
ABF3642-18	\$872	White	42" x 36" x 3" (8)
ABF3642-13	\$916	Biscuit	42" x 36" x 3" (8)
*Not compatible with alcove configuration			
ABF3648-18	\$872	White	60" x 36" x 3" (10)
ABF3648-13	\$916	Biscuit	60" x 36" x 3" (10)
ABF3660-18	\$872	White	60" x 36" x 3" (19)
ABF3660-13	\$916	Biscuit	60" x 36" x 3" (19)
*Not compatible with alcove configuration			
ABF3672-18	\$964	White	72" x 36" x 3" (21)
ABF3672-13	\$1,013	Biscuit	72" x 36" x 3" (21)

DIMENSIONS					
		V56314-11-40①	\$1,176	Bright Chrome	CLEAR
		V56314-25-40 _	\$1,261	Brushed Nickel	CLEAR
		V56314-29-40 _	\$1,357	Oil-Rubbed Bronze	CLEAR
		V56315-11-40①-③	\$1,645	Bright Chrome	CLEAR
		V56315-25-40 _ _	\$1,729	Brushed Nickel	CLEAR
		V56315-29-40 _ _	\$1,848	Oil-Rubbed Bronze	CLEAR

BASE	PRICE	COLOR	SIZE
ABF3642-18	\$714	White	42" x 36" x 3" (8)
ABF3642-13	\$751	Biscuit	42" x 36" x 3" (8)
*Not compatible with alcove configurations or with return panel.			
ABF3260-18	\$815	White	60" x 32" x 3" (13)
ABF3260-13	\$856	Biscuit	60" x 32" x 3" (13)
*Above base are compatible with models V56314			
ABF3648-18	\$733	White	48" x 36" x 3" (10)
ABF3648-13	\$771	Biscuit	48" x 36" x 3" (10)
*Not compatible with alcove configurations or with return panel.			
ABF3660-18	\$872	White	60" x 36" x 3" (19)
ABF3660-13	\$916	Biscuit	60" x 36" x 3" (19)
ABF3672-18	\$964	White	72" x 36" x 3" (21)
ABF3672-13	\$1,013	Biscuit	72" x 36" x 3" (21)

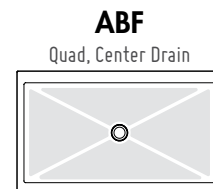
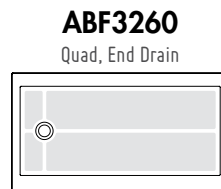

▶ For base shapes please view the end of the section.

- ADDITIONAL RETURN PANEL SIZES ARE AVAILABLE.
- CONTACT CUSTOMER SERVICE FOR DETAILS.

## SELECT OPTIONS

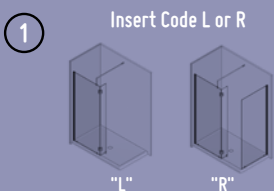

③ Insert Code H (flat) or Y (round) to select OPTIONAL TOWEL BAR

Towel Bar installs onto a return panel

Available in two finishes:  
CHROME - Surcharge \$233  
BRUSHED - Surcharge \$216

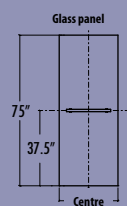

**DRAIN**  
NO-CALK™  
SHOWER BASE DRAIN\*  
SEE PAGE 5



Glass surface protection  
See information sheet at the end of this section.

**OPTIONAL**



6' WALK-IN SHOWER SYSTEM



# 6' 6" WALK-IN SHOWER SYSTEM (CONT'D)

3/8" (10 mm) Clear Tempered Glass • 75" H (82 3/16" to top of support bar)

DIMENSIONS		MODEL	PRICE	FINISH	GLASS
		V6302-11-40 ①-③	\$2,064	Bright Chrome	CLEAR
		V6302-25-40 _ - _	\$2,231	Brushed Nickel	CLEAR
		V6302-29-40 _ - _	\$2,387	Oil-Rubbed Bronze	CLEAR
		V6301-11-40	\$1,628	Bright Chrome	CLEAR
		V6301-25-40	\$1,795	Brushed Nickel	CLEAR
		V6301-29-40	\$1,928	Oil-Rubbed Bronze	CLEAR
		V6303-11-40 ③	\$2,578	Bright Chrome	CLEAR
		V6303-25-40 _	\$2,745	Brushed Nickel	CLEAR
		V6303-29-40 _	\$2,949	Oil-Rubbed Bronze	CLEAR

BASE	PRICE	COLOR	SIZE	
ABF3672-18	\$964	White	72" x 36" x 3"	(21)
ABF3672-13	\$1,013	Biscuit	72" x 36" x 3"	(21)

CONTINUED ON NEXT PAGE

### ABF

Quad, Center Drain

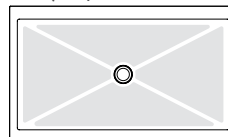

DRAIN NO-CALK™ SHOWER BASE DRAIN*	DRAINABS-11		ABS No-Calk 2" drain		\$30	Chrome
		DRAINABS-25	ABS No-Calk 2" drain	\$40		
	DRAINPVC-11	PVC No-Calk 2" drain	\$30	Chrome	\$40	Brushed Nickel
	DRAINPVC-11	PVC No-Calk 2" drain	\$40	Brushed Nickel		

\*Please check local codes to ensure appropriate drain specifications

For base shapes please view the end of the section.

- ADDITIONAL RETURN PANEL SIZES ARE AVAILABLE.
- CONTACT CUSTOMER SERVICE FOR DETAILS.

## SELECT OPTIONS

1

Insert Code L or R

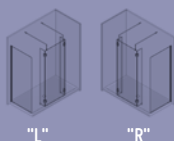

3

Insert Code H (flat) or Y (round) to select OPTIONAL TOWEL BAR

Towel Bar installs onto a return panel

Available in two finishes:  
CHROME - Surcharge \$233  
BRUSHED - Surcharge \$216

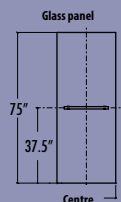

Glass surface protection  
See information sheet at the end of this section.

OPTIONAL



6' WALK-IN SHOWER SYSTEM



# 6' 6" WALK-IN SHOWER SYSTEM (CONT'D)

3/8" (10 mm) Clear Tempered Glass • 75" H (82 3/16" to top of support bar)

ROUND TOP	SQUARE TOP	DIMENSIONS	ROUND MODEL	SQUARE MODEL	PRICE	FINISH	GLASS
			V6305-11-40 <sup>②</sup>	VW6305-11-40 <sup>②</sup>	\$1,940	Bright Chrome	CLEAR
			V6305-25-40 __	VW6305-25-40 __	\$2,143	Brushed Nickel	CLEAR
			V6305-29-40 __	VW6305-29-40 __	\$2,299	Oil-Rubbed Bronze	CLEAR
			V6306-11-40- <sup>②</sup> <sup>③</sup>	VW6306-11-40- <sup>②</sup> <sup>③</sup>	\$2,455	Bright Chrome	CLEAR
			V6306-25-40 __	VW6306-25-40 __	\$2,670	Brushed Nickel	CLEAR
			V6306-29-40 __	VW6306-29-40 __	\$2,863	Oil-Rubbed Bronze	CLEAR
			V6308-11-40- <sup>②</sup> <sup>③</sup>	VW6308-11-40- <sup>②</sup> <sup>③</sup>	\$2,971	Bright Chrome	CLEAR
			V6308-25-40 __	VW6308-25-40 __	\$3,198	Brushed Nickel	CLEAR
			V6308-29-40 __	VW6308-29-40 __	\$3,438	Oil-Rubbed Bronze	CLEAR

*Shown with optional Towel Bar*

BASE	PRICE	COLOR	SIZE	
ABF3672-18	\$964	White	72" x 36" x 3"	(21)
ABF3672-13	\$1,013	Biscuit	72" x 36" x 3"	(21)

CONTINUED ON NEXT PAGE

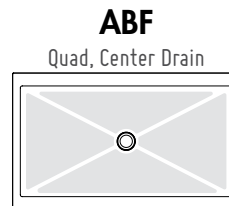

DRAIN NO-CALK™ SHOWER BASE DRAIN*	DRAINABS-11		ABS No-Calk 2" drain		\$30	Chrome
		DRAINABS-25	ABS No-Calk 2" drain	\$40		
	DRAINPVC-11	PVC No-Calk 2" drain	\$30	Chrome	\$40	Brushed Nickel
	DRAINPVC-11	PVC No-Calk 2" drain	\$40	Brushed Nickel		

\*Please check local codes to ensure appropriate drain specifications

For base shapes please view the end of the section.

- ADDITIONAL RETURN PANEL SIZES ARE AVAILABLE.
- CONTACT CUSTOMER SERVICE FOR DETAILS.

## SELECT OPTIONS

② Insert Code M, Q, T or R

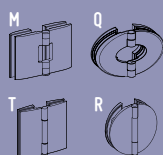

③ Insert Code H (flat) or Y (round) to select OPTIONAL TOWEL BAR

Towel Bar installs onto a return panel

Available in two finishes:  
CHROME - Surcharge \$233  
BRUSHED - Surcharge \$216

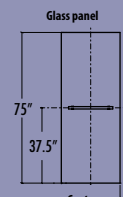

Glass surface protection See information sheet at the end of this section.

OPTIONAL



6' WALK-IN SHOWER SYSTEM



# 6' 6" WALK-IN SHOWER SYSTEM (CONT'D)

3/8" (10 mm) Clear Tempered Glass • 75" H (82 3/16" to top of support bar)

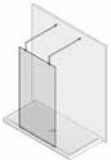
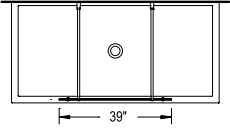
DIMENSIONS		MODEL	PRICE	FINISH	GLASS
		V6309-11-40 ③	\$824	Bright Chrome	CLEAR
		V6309-25-40 _	\$897	Brushed Nickel	CLEAR
		V6309-29-40 _	\$968	Oil-Rubbed Bronze	CLEAR

BASE	PRICE	COLOR	SIZE
ABF3642-18	\$714	White	42" x 36" x 3" (8)
ABF3642-13	\$751	Biscuit	42" x 36" x 3" (8)
ABF3648-18	\$733	White	48" x 36" x 3" (10)
ABF3648-13	\$771	Biscuit	48" x 36" x 3" (10)
ABF3260-18	\$815	White	60" x 32" x 3" (13)
ABF3260-13	\$856	Biscuit	60" x 32" x 3" (13)
ABF3660-18	\$872	White	60" x 36" x 3" (19)
ABF3660-13	\$916	Biscuit	60" x 36" x 3" (19)
ABF3672-18	\$964	White	72" x 36" x 3" (21)
ABF3672-13	\$1,013	Biscuit	72" x 36" x 3" (21)

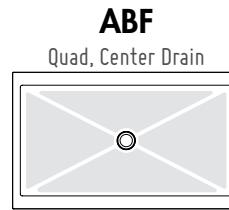

All bases are not compatible with alcove configurations

## Support bar dimensions

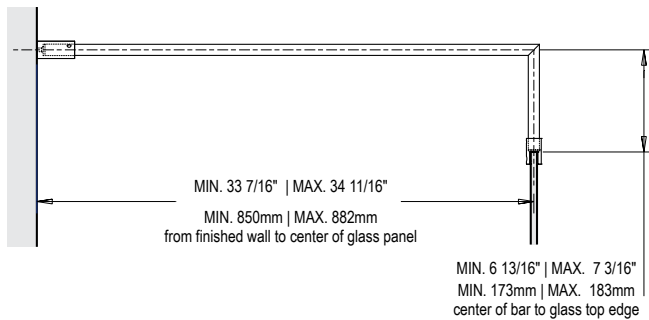

DRAIN NO-CALK™ SHOWER BASE DRAIN*	ABS		PVC		
	Model	Description	Model	Description	
	DRAINABS-11	ABS No-Calk 2" drain	\$30	Chrome	
	DRAINABS-25	ABS No-Calk 2" drain	\$40	Brushed Nickel	
	DRAINPVC-11	PVC No-Calk 2" drain	\$30	Chrome	
	DRAINPVC-11	PVC No-Calk 2" drain	\$40	Brushed Nickel	

\*Please check local codes to ensure appropriate drain specifications

▶ For base shapes please view the end of the section.

## SELECT OPTIONS

③ Insert Code H (flat) or Y (round) to select OPTIONAL TOWEL BAR

Towel Bar installs onto a panel

Available in two finishes:  
CHROME - Surcharge \$233  
BRUSHED - Surcharge \$216

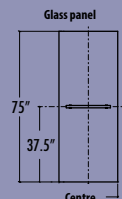

Glass surface protection  
See information sheet at the end of this section.

**OPTIONAL**



MODEL V6636-11-40R

[www.designashower.com](http://www.designashower.com)

 FLEURCO™

79" H (86 13/16" to top of support bar) • Approx. entry : 22"

5/16" (8 mm) CLEAR TEMPERED GLASS

MODEL	PRICE	FINISH	GLASS
V6636-11-40 ①	\$1,184	Bright Chrome	CLEAR
V6636-25-40 _	\$1,268	Brushed Nickel	CLEAR
V6636-29-40 _	\$1,365	Oil-Rubbed Bronze	CLEAR

BASE	PRICE	COLOR	SIZE	
ABSL66-18L	\$935	White	66" x 38" x 5"	(84)
ABSL66-18R	\$935	White	66" x 38" x 5"	(85)

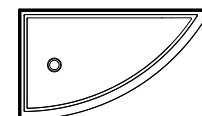
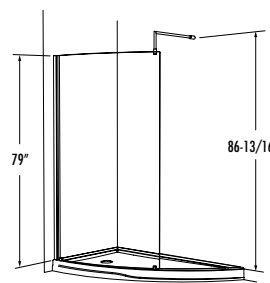

**ABSL66-18L**  
Flanged Slice, End Drain  
Left Side Configuration

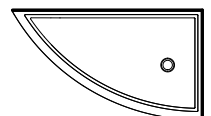

**ABSL66-18R**  
Flanged Slice, End Drain  
Right Side Configuration

### SELECT OPTIONS

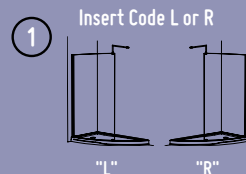

Glass surface protection  
See information sheet at  
the end of this section.

**OPTIONAL**

▶ For base shapes please view the end of the section.

# Microtek Glass Protector



Protect your shower glass and extend its life by choosing Microtek, Fleurco's unique water repellent coating. Microtek uses the latest technology to offer easy maintenance and a hygienic environment. Microtek protects your glass for up to ten years.

## COMPARED WITH ORDINARY GLASS, MICROTEK:

- Resists staining from hard water deposits.
- Is easier to clean.
- Does not support the growth of bacteria.
- Eliminates the need for harsh and abrasive cleaning products.

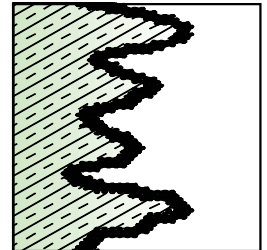

## YOUR GLASS PROTECTED WITH MICROTEK

- Saves time and effort.
- Stays cleaner longer.
- Creates a more hygienic environment.



## PRECAUTIONS

- Avoid using abrasive cleaners.
- Hydrofluoric and phosphoric acid can damage glass surface and should not be used.
- Do not use abrasive scouring powders or pads, highly acidic/alkaline cleaners, brushers, razor blades or other sharp objects which may scratch or harm the glass surface.

## MAINTENANCE

A soft cloth is all you need to clean your protected glass. For best results, squeegee dry after each use.



## ORDER INFORMATION

### WHEN ORDERING A DOOR WITH MICROTEK:

- Must be on a separate P.O.
- P.O. must contain the Item Number.
- On a separate line it must be marked with Microtek code (CS-1) and Left or Right as per the information / product line below.
- \$ 160/ panel.

### PLATINUM

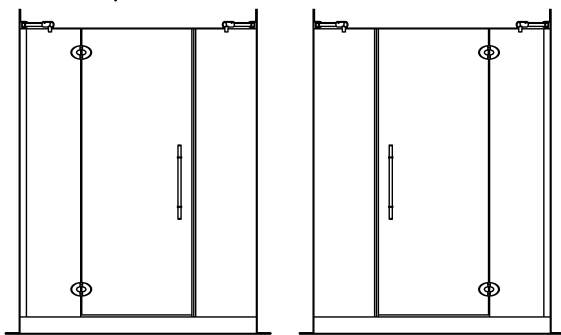

L

THE HINGES ARE INSTALLED ON LEFT SIDE OF DOOR AS VIEWED FROM THE EXTERIOR

R

THE HINGES ARE INSTALLED ON RIGHT SIDE OF DOOR AS VIEWED FROM THE EXTERIOR

### EVOLUTION

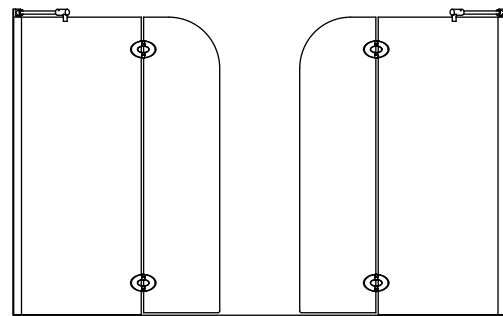

L

THE HINGES ARE INSTALLED ON LEFT SIDE OF PANEL AS VIEWED FROM THE EXTERIOR

R

THE HINGES ARE INSTALLED ON RIGHT SIDE OF PANEL AS VIEWED FROM THE EXTERIOR

#### EXAMPLE

#### LIST

Model # PXT57-11-40	\$ 2 154.00
CS-1 ( 3 PANELS / 1 SIDE ) Specify L or R (see above)	\$ 480.00

#### EXAMPLE

#### LIST

Model # VXSH24-11-40	\$ 1 305.00
CS-1 ( 2 PANELS / 1 SIDE ) Specify L or R (see above)	\$ 320.00

## DURABILITY GUIDELINES

MICROTEK IS EXPECTED TO PERFORM FOR UP TO

**10 YEARS**

## WARRANTY

Provided the glass is maintained according to published after-care instructions and without the use of abrasive cleaning methods or highly alkaline products, FLEURCO warrants that Microtek will work for up to ten (10) years from the date of application.