

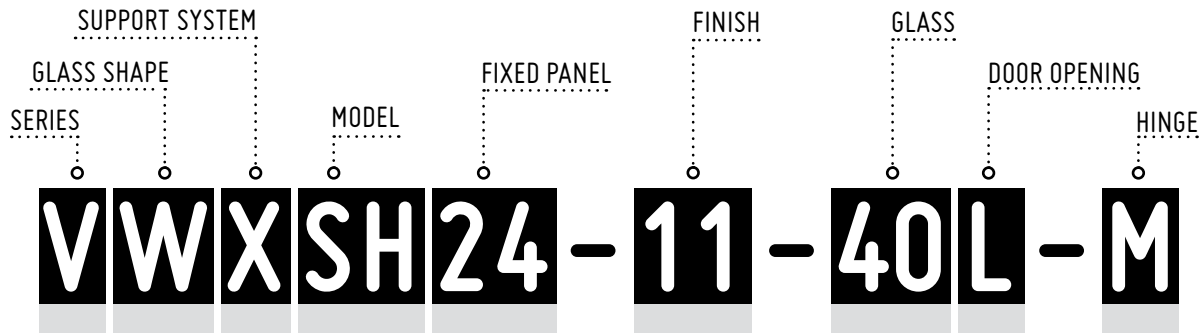

EVOLUTION

MONACO SERIES



4', 5' AND 6' SERIES

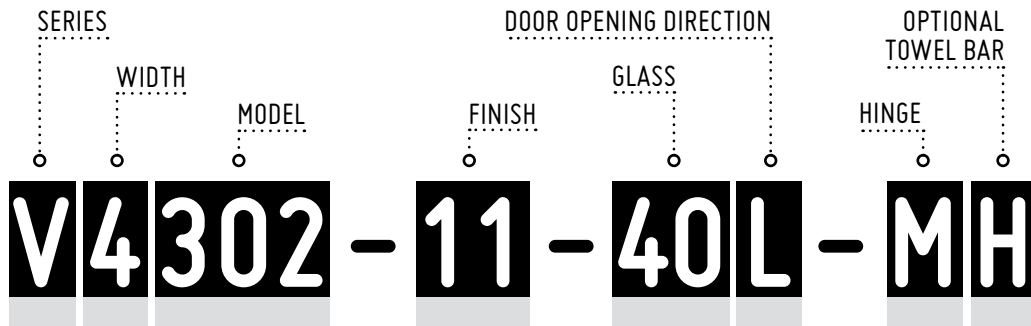

SERIES — V EVOLUTION		
<p>MONACO SERIES SUPPORT SYSTEMS</p> <p>X SUPPORT BAR SYSTEM</p> <p>G GLASS SHELF SUPPORT*</p> <p><small>*Rectangular "M" and Square "T" Hinges come with SQUARE Glass Shelf Support BRACKETS.</small></p> <p><small>*Oval "Q" and Round "R" Hinges come with ROUND Glass Shelf Support BRACKETS.</small></p>	<p>WIDTH</p> <p>4 4' WIDE MODELS</p> <p>56 5' & 6' WIDE MODELS</p> <p>6 6' WIDE MODELS</p>	<p>DOOR OPENING DIRECTION</p> <p>R RIGHT OPENING</p> <p>L LEFT OPENING</p>
<p>MONACO SERIES MODELS</p> <p>SH TUB SHIELD</p> <p>SS SHOWER SHIELD</p>	<p>METAL FINISHES</p> <p>11 BRIGHT CHROME</p> <p>12 BRIGHT BRASS</p> <p>25 BRUSHED NICKEL</p> <p>29 OIL-RUBBED BRONZE</p>	<p>HINGES</p> <p>M RECTANGULAR</p> <p>Q OVAL</p> <p>T SQUARE</p> <p>R ROUND</p>
<p>MONACO SERIES FIXED PANEL</p> <p>FIXED PANEL WIDTH</p>	<p>GLASS</p> <p>40 CLEAR GLASS</p> <p>80 MIST GLASS</p>	<p>TOWEL BAR</p> <p>H FLAT TOWEL BAR</p> <p>Y ROUND TOWEL BAR</p>

11 Bright Chrome

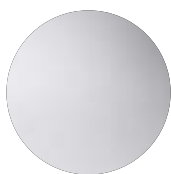

12 Bright Brass

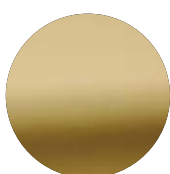

25 Brushed Nickel



29 Oil-Rubbed Bronze

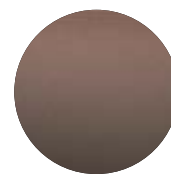



MODEL NUMBER EXPLANATIONS	2
EXAMPLE OF CODE SYSTEM	4
PRODUCT OPTIONS	5
FEATURES	6 - 7
<hr/>	
MONACO SQUARE TOP TUB SHIELD WITH FIXED PANEL	8 - 9
MONACO SQUARE TOP SHOWER SHIELD WITH FIXED PANEL	10 - 11
MONACO ROUND TOP TUB SHIELD WITH FIXED PANEL	12 - 13
MONACO ROUND TOP SHOWER SHIELD WITH FIXED PANEL	14 - 15
SOLO TUB SHIELD	16 - 17
4' AND 5' WALK-IN SHOWER SYSTEM	18 - 19
5' AND 6' WALK-IN SHOWER SYSTEM	20 - 25
6' WALK-IN SHOWER SYSTEM	26 - 31
ECLIPSE CURVED GLASS WALK-IN SHOWER SYSTEM	32
<hr/>	
MICROTEK - GLASS SURFACE PROTECTION	33 - 34

MONACO SERIES



GLASS SHELF SUPPORT - "G"

SUPPORT BAR SYSTEM - "X"

SELECT YOUR DOOR OPENING DIRECTION AND HINGE STYLE



*FOR MODELS WITH GLASS SHELF SUPPORT - "G"
 Rectangular and Square Hinges come with Square Glass Shelf Brackets.
 Oval and Round Hinges come with Round Glass Shelf Brackets.
**Available in 3/8" (10-mm) Clear Glass only.*

VWGSH**24**-**11**-**40L**-**M**

- EVOLUTION
- SQUARE TOP SHIELD
- GLASS SHELF SUPPORT
- TUB SHIELD
- 24" FIXED PANEL
- BRIGHT CHROME FINISH
- CLEAR GLASS
- LEFT OPENING DIRECTION
- RECTANGULAR HINGES

4', 5' and 6' SERIES



SELECT YOUR DOOR OPENING DIRECTION, HINGE STYLE AND OPTIONAL TOWEL BAR



V4302-**11**-**40L**-**T****H**

- EVOLUTION
- WIDTH - 4 FEET
- MODEL
- BRIGHT CHROME FINISH
- CLEAR GLASS
- LEFT OPENING DIRECTION
- SQUARE HINGES
- OPTIONAL FLAT TOWEL BAR (NOT SHOWN)

**1 IDENTIFY OPENING DIRECTION
THIS IS MANDATORY**

VWXSS24-11-40**L**-T

OPENING DIRECTION

FOR MODELS WITHOUT HINGES

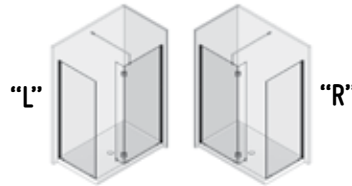

"L" (LEFT) or "R" (RIGHT) indicates the entry location as viewed from the exterior.

FOR MODELS WITH HINGES

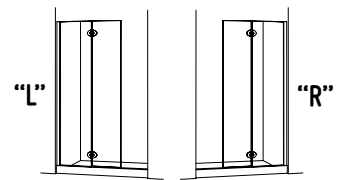

"L" (LEFT) or "R" (RIGHT) indicates where the hinges are installed on the shield panel as viewed from the exterior.

**2 SELECT SOLID BRASS HINGE STYLE
THIS IS MANDATORY**

V4302-11-40**L**-**T**H

HINGE STYLE

M Rectangular



Q Oval



T Square



R Round

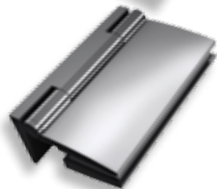

**3 SELECT UV BONDED TOWEL BAR
[SURCHARGE APPLIES]**

AVAILABLE FOR CERTAIN MODELS ONLY. INSTALLATION POSITION VARIES FOR EACH MODEL. SEE INDIVIDUAL MODEL PAGES FOR POSITION.



V4302-25-40**L**-**Q**H

OPTIONAL FLAT TOWEL BAR



V4302-11-40**L**-**Q**Y

OPTIONAL ROUND TOWEL BAR

Available in two finishes:
Chrome - Surcharge \$ 215
Brushed - Surcharge \$ 200

FEATURES

EUROPEAN STYLE FRAMELESS DOORS

TEMPERED GLASS THICKNESS:
3/8" (10 mm) OR 1/4" (6 mm)
5/16" (8 mm) FOR CURVED
GLASS PANELS

GLASS AVAILABLE IN CLEAR AND MIST*

**MIST AVAILABLE FOR CERTAIN MODELS ONLY*

75" HIGH GLASS PANELS FOR
SHOWER MODELS

OPTIONAL MICROTEK
GLASS SURFACE PROTECTION

MULTIPLE CONFIGURATIONS

CUSTOM SIZES AVAILABLE

10-YEAR LIMITED WARRANTY

EUROPEAN STYLE
SUPPORT BARS

PVC SEAL FOR
WATER RETENTION

4 HINGE SHAPES
4 FINISHES

ADJUSTABLE WALL JAMBS

OPTIONAL
TOWEL BAR

DEFLECTOR SHIELD
TECHNOLOGY

MONACO

SQUARE TOP TUB SHIELD WITH FIXED PANEL



SQUARE TOP TUB SHIELD WITH FIXED PANEL

Available with your choice of two support systems

MONACO Door 15" W • Fixed Panel 25 1/4" to 25 7/8" W
58" H (59 1/2" to top of support bar)

MODEL	PRICE	FINISH	GLASS
3/8" (10 mm) Clear Tempered Glass			
SUPPORT BAR SYSTEM			
VWXSH24-11-40 ①-②	\$1,206	Bright Chrome	CLEAR
VWXSH24-12-40 _ _	\$1,230	Bright Brass	CLEAR
VWXSH24-25-40 _ _	\$1,341	Brushed Nickel	CLEAR
VWXSH24-29-40 _ _	\$1,432	Oil-Rubbed Bronze	CLEAR

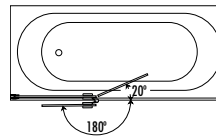
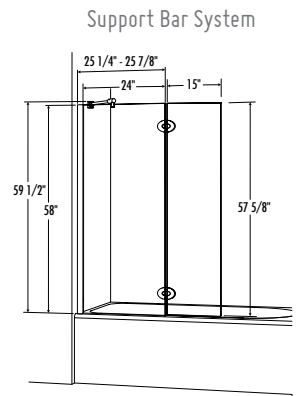

MONACO

MODEL	PRICE	FINISH	GLASS
3/8" (10 mm) Clear Tempered Glass			
GLASS SHELF SUPPORT			
VWGS24-11-40 ①-②	\$1,206	Bright Chrome	CLEAR
VWGS24-12-40 _ _	\$1,230	Bright Brass	CLEAR
VWGS24-25-40 _ _	\$1,341	Brushed Nickel	CLEAR
VWGS24-29-40 _ _	\$1,432	Oil-Rubbed Bronze	CLEAR

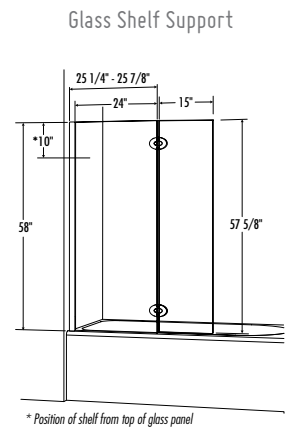

SUPPORT BAR SYSTEM - "X"



SELECT OPTIONS

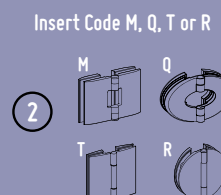
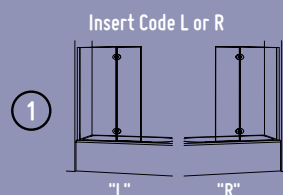

MONACO

SQUARE TOP SHOWER SHIELD WITH FIXED PANEL



SQUARE TOP SHOWER SHIELD WITH FIXED PANEL

Available with your choice of two support systems

Door 15" W • Fixed Panel 24 1/4" to 24 7/8" W
75" H (76 1/2" to top of support bar)

MODEL	PRICE	FINISH	GLASS
3/8" (10 mm) Clear Tempered Glass			
SUPPORT BAR SYSTEM			
VWXSS24-11-40①-②	\$1,275	Bright Chrome	CLEAR
VWXSS24-12-40 _ _	\$1,300	Bright Brass	CLEAR
VWXSS24-25-40 _ _	\$1,388	Brushed Nickel	CLEAR
VWXSS24-29-40 _ _	\$1,501	Oil-Rubbed Bronze	CLEAR
*BASE	PRICE	COLOR	SIZE
ABF3642-13K	\$694	Biscuit	36" x 42" x 2 3/4"
ABF3642-18K	\$660	White	36" x 42" x 2 3/4"
ABF3648-13K	\$713	Biscuit	36" x 48" x 2 3/4"
ABF3648-18K	\$678	White	36" x 48" x 2 3/4"
ABF3260-13K	\$791	Biscuit	32" x 60" x 3"
ABF3260-18K	\$754	White	32" x 60" x 3"
ABF3660-13K	\$847	Biscuit	36" x 60" x 2 3/4"
ABF3660-18K	\$806	White	36" x 60" x 2 3/4"
ABF4260-13K	\$889	Biscuit	42" x 60" x 2 3/4"
ABF4260-18K	\$847	White	42" x 60" x 2 3/4"
ABF4860-13K	\$986	Biscuit	48" x 60" x 2 3/4"
ABF4860-18K	\$938	White	48" x 60" x 2 3/4"

Door 15" W • Fixed Panel 24 1/4" to 24 7/8" W
75" H

MODEL	PRICE	FINISH	GLASS
3/8" (10 mm) Clear Tempered Glass			
GLASS SHELF SUPPORT			
VWGSS24-11-40①-②	\$1,275	Bright Chrome	CLEAR
VWGSS24-12-40 _ _	\$1,300	Bright Brass	CLEAR
VWGSS24-25-40 _ _	\$1,388	Brushed Nickel	CLEAR
VWGSS24-29-40 _ _	\$1,501	Oil-Rubbed Bronze	CLEAR
*BASE	PRICE	COLOR	SIZE
ABF3642-13K	\$694	Biscuit	36" x 42" x 2 3/4"
ABF3642-18K	\$660	White	36" x 42" x 2 3/4"
ABF3648-13K	\$713	Biscuit	36" x 48" x 2 3/4"
ABF3648-18K	\$678	White	36" x 48" x 2 3/4"
ABF3260-13K	\$791	Biscuit	32" x 60" x 3"
ABF3260-18K	\$754	White	32" x 60" x 3"
ABF3660-13K	\$847	Biscuit	36" x 60" x 2 3/4"
ABF3660-18K	\$806	White	36" x 60" x 2 3/4"
ABF4260-13K	\$889	Biscuit	42" x 60" x 2 3/4"
ABF4260-18K	\$847	White	42" x 60" x 2 3/4"
ABF4860-13K	\$986	Biscuit	48" x 60" x 2 3/4"
ABF4860-18K	\$938	White	48" x 60" x 2 3/4"

ABF

Acrylic Base



ABF3260

Side Drain Acrylic Base



SUPPORT BAR SYSTEM - "X"



Support Bar System

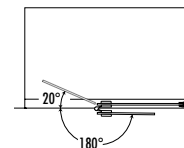
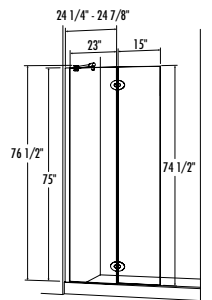

Glass Shelf Support

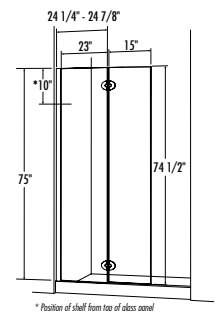

SELECT OPTIONS

*SEE BASE SECTION FOR ADDITIONAL COMPATIBLE SHOWER MODELS AND TECHNICAL SPECIFICATIONS

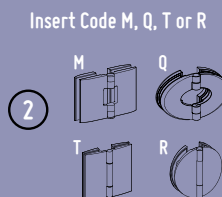
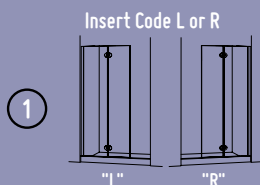

MONACO

ROUND TOP TUB SHIELD WITH FIXED PANEL



ROUND TOP TUB SHIELD WITH FIXED PANEL

Available with your choice of two support systems

Door 15" W • Fixed Panel 25 1/4" to 25 7/8" W
58" H (59 1/2" to top of support bar)

3/8" (10 mm) Tempered Glass			
MODEL	PRICE	FINISH	GLASS
SUPPORT BAR SYSTEM			
CLEAR Tempered Glass 3/8" (10 mm)			
VXSH24-11-40①-②	\$1,206	Bright Chrome	CLEAR
VXSH24-12-40 _ _	\$1,230	Bright Brass	CLEAR
VXSH24-25-40 _ _	\$1,341	Brushed Nickel	CLEAR
VXSH24-29-40 _ _	\$1,432	Oil-Rubbed Bronze	CLEAR
MIST Tempered Glass 3/8" (10 mm)			
VXSH24-11-80①-②	\$1,349	Bright Chrome	MIST
VXSH24-12-80 _ _	\$1,374	Bright Brass	MIST
VXSH24-25-80 _ _	\$1,484	Brushed Nickel	MIST
VXSH24-29-80 _ _	\$1,575	Oil-Rubbed Bronze	MIST

1/4" (6 mm) Tempered Glass			
MODEL	PRICE	FINISH	GLASS
SUPPORT BAR SYSTEM			
CLEAR Tempered Glass 1/4" (6 mm)			
VSH24-11-40①-②	\$868	Bright Chrome	CLEAR
VSH24-12-40 _ _	\$893	Bright Brass	CLEAR
VSH24-25-40 _ _	\$1,003	Brushed Nickel	CLEAR
VSH24-29-40 _ _	\$1,094	Oil-Rubbed Bronze	CLEAR
<i>The above models are only available with the support bar system</i>			
MIST Tempered Glass 1/4" (6 mm)			
VSH24-11-80①-②	\$1,109	Bright Chrome	MIST
VSH24-12-80 _ _	\$1,134	Bright Brass	MIST
VSH24-25-80 _ _	\$1,244	Brushed Nickel	MIST
VSH24-29-80 _ _	\$1,336	Oil-Rubbed Bronze	MIST
<i>The above models are only available with the support bar system</i>			

SUPPORT BAR SYSTEM - "X"



Door 15" W • Fixed Panel 25 1/4" to 25 7/8" W
58" H

3/8" (10 mm) Tempered Glass			
MODEL	PRICE	FINISH	GLASS
*GLASS SHELF SUPPORT			
CLEAR Tempered Glass 3/8" (10 mm)			
VGSH24-11-40①-②	\$1,206	Bright Chrome	CLEAR
VGSH24-12-40 _ _	\$1,230	Bright Brass	CLEAR
VGSH24-25-40 _ _	\$1,341	Brushed Nickel	CLEAR
VGSH24-29-40 _ _	\$1,432	Oil-Rubbed Bronze	CLEAR
MIST Tempered Glass 3/8" (10 mm)			
VGSH24-11-80①-②	\$1,349	Bright Chrome	MIST
VGSH24-12-80 _ _	\$1,374	Bright Brass	MIST
VGSH24-25-80 _ _	\$1,484	Brushed Nickel	MIST
VGSH24-29-80 _ _	\$1,575	Oil-Rubbed Bronze	MIST
<i>*Glass Shelves are available in 3/8" (10 mm) Clear Glass only.</i>			

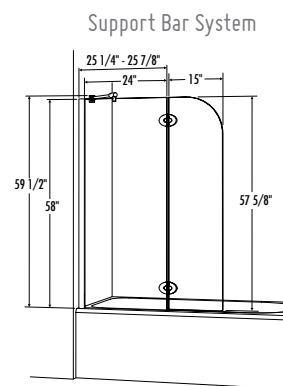
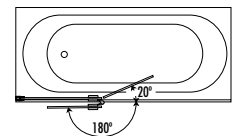
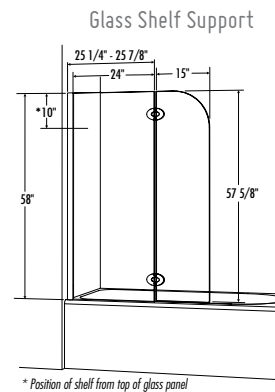

SELECT OPTIONS

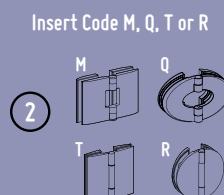
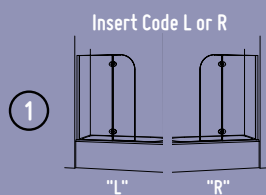

MONACO

ROUND TOP SHOWER SHIELD WITH FIXED PANEL



ROUND TOP SHOWER SHIELD WITH FIXED PANEL

Available with your choice of two support systems

Door 15" W • Fixed Panel 24 1/4" to 24 7/8" W
75" H (76 1/2" to top of support bar)

MODEL	PRICE	FINISH	GLASS
SUPPORT BAR SYSTEM			
CLEAR Tempered Glass 3/8" (10 mm)			
VXSS24-11-40①-②	\$1,275	Bright Chrome	CLEAR
VXSS24-12-40 _ _	\$1,300	Bright Brass	CLEAR
VXSS24-25-40 _ _	\$1,388	Brushed Nickel	CLEAR
VXSS24-29-40 _ _	\$1,501	Oil-Rubbed Bronze	CLEAR
MIST Tempered Glass 3/8" (10 mm)			
VXSS24-11-80①-②	\$1,393	Bright Chrome	MIST
VXSS24-12-80 _ _	\$1,417	Bright Brass	MIST
VXSS24-25-80 _ _	\$1,506	Brushed Nickel	MIST
VXSS24-29-80 _ _	\$1,618	Oil-Rubbed Bronze	MIST
*BASE	PRICE	COLOR	SIZE
ABF3642-13K	\$694	Biscuit	36" x 42" x 2 3/4"
ABF3642-18K	\$660	White	36" x 42" x 2 3/4"
ABF3648-13K	\$713	Biscuit	36" x 48" x 2 3/4"
ABF3648-18K	\$678	White	36" x 48" x 2 3/4"
ABF3260-13K	\$791	Biscuit	32" x 60" x 3"
ABF3260-18K	\$754	White	32" x 60" x 3"
ABF3660-13K	\$847	Biscuit	36" x 60" x 2 3/4"
ABF3660-18K	\$806	White	36" x 60" x 2 3/4"
ABF4260-13K	\$889	Biscuit	42" x 60" x 2 3/4"
ABF4260-18K	\$847	White	42" x 60" x 2 3/4"
ABF4860-13K	\$986	Biscuit	48" x 60" x 2 3/4"
ABF4860-18K	\$938	White	48" x 60" x 2 3/4"

ABF

Acrylic Base



ABF3260

Side Drain Acrylic Base



SUPPORT BAR SYSTEM - "X"



Door 15" W • Fixed Panel 24 1/4" to 24 7/8" W
75" H

MODEL	PRICE	FINISH	GLASS
*GLASS SHELF SUPPORT			
CLEAR Tempered Glass 3/8" (10 mm)			
VGSS24-11-40①-②	\$1,275	Bright Chrome	CLEAR
VGSS24-12-40 _ _	\$1,300	Bright Brass	CLEAR
VGSS24-25-40 _ _	\$1,388	Brushed Nickel	CLEAR
VGSS24-29-40 _ _	\$1,501	Oil-Rubbed Bronze	CLEAR
MIST Tempered Glass 3/8" (10 mm)			
VGSS24-11-80①-②	\$1,393	Bright Chrome	MIST
VGSS24-12-80 _ _	\$1,417	Bright Brass	MIST
VGSS24-25-80 _ _	\$1,506	Brushed Nickel	MIST
VGSS24-29-80 _ _	\$1,618	Oil-Rubbed Bronze	MIST
<i>*Glass Shelves are available in 3/8" (10 mm) Clear Glass only.</i>			
*BASE	PRICE	COLOR	SIZE
ABF3642-13K	\$694	Biscuit	36" x 42" x 2 3/4"
ABF3642-18K	\$660	White	36" x 42" x 2 3/4"
ABF3648-13K	\$713	Biscuit	36" x 48" x 2 3/4"
ABF3648-18K	\$678	White	36" x 48" x 2 3/4"
ABF3260-13K	\$791	Biscuit	32" x 60" x 3"
ABF3260-18K	\$754	White	32" x 60" x 3"
ABF3660-13K	\$847	Biscuit	36" x 60" x 2 3/4"
ABF3660-18K	\$806	White	36" x 60" x 2 3/4"
ABF4260-13K	\$889	Biscuit	42" x 60" x 2 3/4"
ABF4260-18K	\$847	White	42" x 60" x 2 3/4"
ABF4860-13K	\$986	Biscuit	48" x 60" x 2 3/4"
ABF4860-18K	\$938	White	48" x 60" x 2 3/4"

NEW

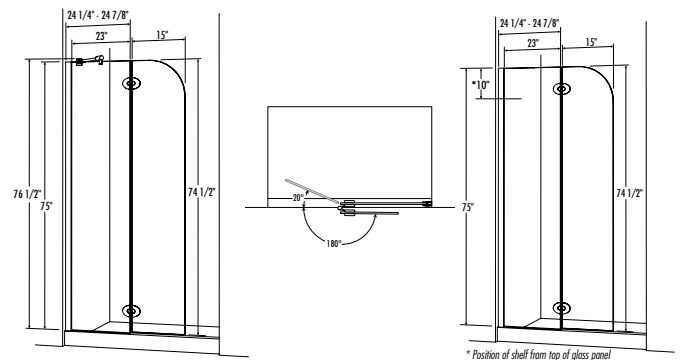

* Position of shelf from top of glass panel

SELECT OPTIONS

*SEE BASE SECTION FOR ADDITIONAL COMPATIBLE SHOWER MODELS AND TECHNICAL SPECIFICATIONS

Insert Code L or R

①

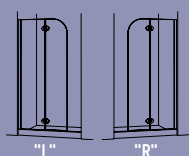

Insert Code M, Q, T or R

②

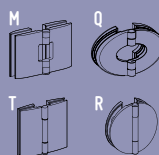

SOLO TUB SHIELD





SOLO 29" W x 63" H

3/8" (10 mm) Clear Tempered Glass

MODEL	PRICE	FINISH	GLASS
VXT029-11-40①-②	\$819	Bright Chrome	CLEAR
VXT029-12-40 _ _	\$842	Bright Brass	CLEAR
VXT029-25-40 _ _	\$881	Brushed Nickel	CLEAR
VXT029-29-40 _ _	\$959	Oil-Rubbed Bronze	CLEAR

1/4" (6 mm) Clear Tempered Glass

MODEL	PRICE	FINISH	GLASS
VT029-11-40①-②	\$668	Bright Chrome	CLEAR
VT029-12-40 _ _	\$691	Bright Brass	CLEAR
VT029-25-40 _ _	\$730	Brushed Nickel	CLEAR
VT029-29-40 _ _	\$809	Oil-Rubbed Bronze	CLEAR

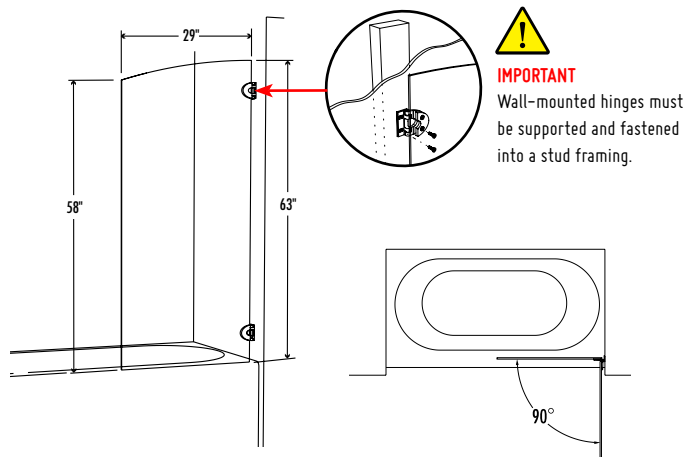

SELECT OPTIONS

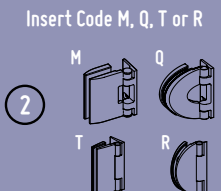
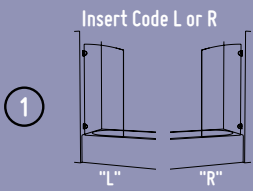

Microtek
by Fleurco

Glass surface protection.
See information sheet at the end of this section for ordering details.

4' AND 5' WALK-IN SHOWER SYSTEM



4' AND 5' WALK-IN SHOWER SYSTEM

3/8" (10 mm) Clear Tempered Glass • 75" H (82 3/16" to top of support bar)

ROUND TOP	SQUARE TOP	DIMENSIONS	ROUND MODEL	SQUARE MODEL	PRICE	FINISH	GLASS
			V4301-11-40 ①-② V4301-12-40 _ _ V4301-25-40 _ _ V4301-29-40 _ _	VW4301-11-40 ①-② VW4301-12-40 _ _ VW4301-25-40 _ _ VW4301-29-40 _ _	\$1,168 \$1,191 \$1,278 \$1,377	Bright Chrome Bright Brass Brushed Nickel Oil-Rubbed Bronze	CLEAR CLEAR CLEAR CLEAR
			V4302-11-40 ①-②③ V4302-12-40 _ _ V4302-25-40 _ _ V4302-29-40 _ _	VW4302-11-40 ①-②③ VW4302-12-40 _ _ VW4302-25-40 _ _ VW4302-29-40 _ _	\$1,572 \$1,594 \$1,682 \$1,780	Bright Chrome Bright Brass Brushed Nickel Oil-Rubbed Bronze	CLEAR CLEAR CLEAR CLEAR

Shown with optional Towel Bar

*BASE	PRICE	COLOR	SIZE
*ABF3642-13K	\$694	Biscuit	36" x 42" x 2 3/4"
*ABF3642-18K	\$660	White	36" x 42" x 2 3/4"
<i>* Not compatible with alcove models or with return panels.</i>			
ABF3648-13K	\$713	Biscuit	36" x 48" x 2 3/4"
ABF3648-18K	\$678	White	36" x 48" x 2 3/4"
ABF3660-13K	\$847	Biscuit	36" x 60" x 2 3/4"
ABF3660-18K	\$806	White	36" x 60" x 2 3/4"
ABF3260HCL-13K	\$883	Biscuit	32" x 60" x 2 3/4"
ABF3260HCL-18K	\$842	White	32" x 60" x 2 3/4"
ABF3260HCR-13K	\$883	Biscuit	32" x 60" x 2 3/4"
ABF3260HCR-18K	\$842	White	32" x 60" x 2 3/4"
ABF3260-13K	\$791	Biscuit	32" x 60" x 3"
ABF3260-18K	\$754	White	32" x 60" x 3"

Above base is compatible with models V4031 and VW4301

*BASE	PRICE	COLOR	SIZE
ABF3660HCL-13K	\$906	Biscuit	36" x 60" x 2 3/4"
ABF3660HCR-18K	\$863	White	36" x 60" x 2 3/4"
ABF3660HCR-13K	\$906	Biscuit	36" x 60" x 2 3/4"
ABF3660HCR-18K	\$863	White	36" x 60" x 2 3/4"



ROUND TOP	SQUARE TOP	DIMENSIONS	ROUND MODEL	SQUARE MODEL	PRICE	FINISH	GLASS
			V4304-11-40 ①-②③ V4304-12-40 _ _ V4304-25-40 _ _ V4304-29-40 _ _	VW4304-11-40 ①-②③ VW4304-12-40 _ _ VW4304-25-40 _ _ VW4304-29-40 _ _	\$1,709 \$1,730 \$1,831 \$1,917	Bright Chrome Bright Brass Brushed Nickel Oil-Rubbed Bronze	CLEAR CLEAR CLEAR CLEAR

*BASE	PRICE	COLOR	SIZE
*ABF3642-13K	\$694	Biscuit	36" x 42" x 2 3/4"
*ABF3642-18K	\$660	White	36" x 42" x 2 3/4"
<i>* Not compatible with alcove models or with return panels.</i>			
ABF3648-13K	\$713	Biscuit	36" x 48" x 2 3/4"
ABF3648-18K	\$678	White	36" x 48" x 2 3/4"
ABF3660-13K	\$847	Biscuit	36" x 60" x 2 3/4"
ABF3660-18K	\$806	White	36" x 60" x 2 3/4"

*BASE	PRICE	COLOR	SIZE
ABF3660HCL-13K	\$906	Biscuit	36" x 60" x 2 3/4"
ABF3660HCR-18K	\$863	White	36" x 60" x 2 3/4"
ABF3660HCR-13K	\$906	Biscuit	36" x 60" x 2 3/4"
ABF3660HCR-18K	\$863	White	36" x 60" x 2 3/4"

• ADDITIONAL RETURN PANEL SIZES ARE AVAILABLE. CONTACT CUSTOMER SERVICE FOR DETAILS.

SELECT OPTIONS

*SEE BASE SECTION FOR ADDITIONAL COMPATIBLE SHOWER MODELS AND TECHNICAL SPECIFICATIONS

Insert Code L or R

1



"L" "R"

Insert Code M, Q, T or R

2

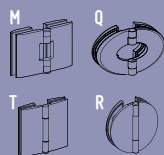

Insert Code H (flat) or Y (round) to select OPTIONAL TOWEL BAR

3

Towel Bar installs onto a Return Panel

Available in two finishes:
CHROME - Surcharge \$215
BRUSHED - Surcharge \$200

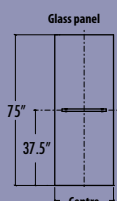

5' AND 6' WALK-IN SHOWER SYSTEM



5' AND 6' WALK-IN SHOWER SYSTEM

3/8" (10 mm) Clear Tempered Glass • 75" H (82 3/16" to top of support bar)

ROUND TOP	SQUARE TOP	DIMENSIONS	ROUND MODEL	SQUARE MODEL	PRICE	FINISH	GLASS
			V56304-11-40 ①-②③	VW56304-11-40 ①-②③	\$1,791	Bright Chrome	CLEAR
			V56304-12-40 _ _ _	VW56304-12-40 _ _ _	\$1,813	Bright Brass	CLEAR
			V56304-25-40 _ _ _	VW56304-25-40 _ _ _	\$1,923	Brushed Nickel	CLEAR
			V56304-29-40 _ _ _	VW56304-29-40 _ _ _	\$2,067	Oil-Rubbed Bronze	CLEAR
			V56305-11-40 ①-②③	VW56305-11-40 ①-②③	\$2,262	Bright Chrome	CLEAR
			V56305-12-40 _ _ _	VW56305-12-40 _ _ _	\$2,282	Bright Brass	CLEAR
			V56305-25-40 _ _ _	VW56305-25-40 _ _ _	\$2,405	Brushed Nickel	CLEAR
			V56305-29-40 _ _ _	VW56305-29-40 _ _ _	\$2,582	Oil-Rubbed Bronze	CLEAR

Shown with optional Towel Bar

*BASE	PRICE	COLOR	SIZE
ABF3660-13K	\$847	Biscuit	36" x 60" x 2 3/4"
ABF3660-18K	\$806	White	36" x 60" x 2 3/4"
ABF3672-13K	\$936	Biscuit	36" x 72" x 2 3/4"
ABF3672-18K	\$891	White	36" x 72" x 2 3/4"

ABF
Acrylic Base



ROUND TOP	SQUARE TOP	DIMENSIONS	ROUND MODEL	SQUARE MODEL	PRICE	FINISH	GLASS
			V56301-11-40 ①-②	VW56301-11-40 ①-②	\$1,201	Bright Chrome	CLEAR
			V56301-12-40 _ _	VW56301-12-40 _ _	\$1,224	Bright Brass	CLEAR
			V56301-25-40 _ _	VW56301-25-40 _ _	\$1,301	Brushed Nickel	CLEAR
			V56301-29-40 _ _	VW56301-29-40 _ _	\$1,401	Oil-Rubbed Bronze	CLEAR
			V56302-11-40 ①-②③	VW56302-11-40 ①-②③	\$1,634	Bright Chrome	CLEAR
			V56302-12-40 _ _ _	VW56302-12-40 _ _ _	\$1,655	Bright Brass	CLEAR
			V56302-25-40 _ _ _	VW56302-25-40 _ _ _	\$1,732	Brushed Nickel	CLEAR
			V56302-29-40 _ _ _	VW56302-29-40 _ _ _	\$1,866	Oil-Rubbed Bronze	CLEAR

Shown with optional Towel Bar

*BASE	PRICE	COLOR	SIZE
ABF3660-13K	\$847	Biscuit	36" x 60" x 2 3/4"
ABF3660-18K	\$806	White	36" x 60" x 2 3/4"
ABF3672-13K	\$936	Biscuit	36" x 72" x 2 3/4"
ABF3672-18K	\$891	White	36" x 72" x 2 3/4"
ABF3660HCL-13K	\$906	Biscuit	36" x 60" x 2 3/4"
ABF3660HCL-18K	\$863	White	36" x 60" x 2 3/4"
ABF3660HCR-13K	\$906	Biscuit	36" x 60" x 2 3/4"
ABF3660HCR-18K	\$863	White	36" x 60" x 2 3/4"
ABF3260-13K	\$791	Biscuit	32" x 60" x 3"
ABF3260-18K	\$754	White	32" x 60" x 3"

Above base is compatible with models V4031 and VW4301

ABF3260
Acrylic Base



ABF3660HC
Acrylic Base



CONTINUED ON NEXT PAGE

• ADDITIONAL RETURN PANEL SIZES ARE AVAILABLE. CONTACT CUSTOMER SERVICE FOR DETAILS.

SELECT OPTIONS

*SEE BASE SECTION FOR ADDITIONAL COMPATIBLE SHOWER MODELS AND TECHNICAL SPECIFICATIONS

Insert Code L or R

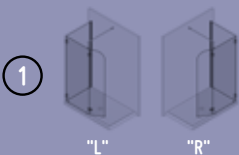

Insert Code M, Q, T or R

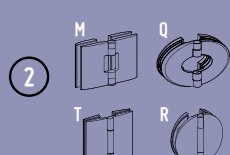

Insert Code H (flat) or Y (round) to select OPTIONAL TOWEL BAR

Towel Bar installs onto a panel

Available in two finishes:
CHROME - Surcharge \$215
BRUSHED - Surcharge \$200

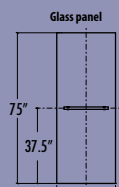



5' AND 6' WALK-IN SHOWER SYSTEM

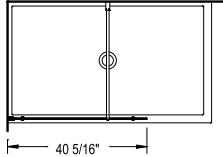

5' AND 6' WALK-IN SHOWER SYSTEM (CONT'D)

3/8" (10 mm) Clear Tempered Glass • 75" H (82 3/16" to top of support bar)

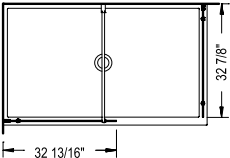
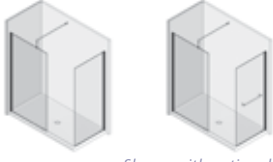
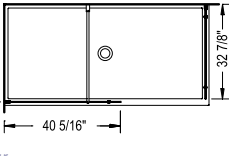
	DIMENSIONS	MODEL	PRICE	FINISH	GLASS
		V56310-11-40 ①-③	\$756	Bright Chrome	CLEAR
		V56310-12-40 _ _	\$777	Bright Brass	CLEAR
		V56310-25-40 _ _	\$799	Brushed Nickel	CLEAR
		V56310-29-40 _ _	\$886	Oil-Rubbed Bronze	CLEAR
 <p><i>Shown with optional Towel Bar</i></p>		V56312-11-40 ①-③	\$1,186	Bright Chrome	CLEAR
		V56312-12-40 _ _	\$1,207	Bright Brass	CLEAR
		V56312-25-40 _ _	\$1,230	Brushed Nickel	CLEAR
		V56312-29-40 _ _	\$1,323	Oil-Rubbed Bronze	CLEAR
 <p><i>Shown with optional Towel Bar</i></p>		V6310-11-40 ①-③	\$1,235	Bright Chrome	CLEAR
		V6310-12-40 _ _	\$1,257	Bright Brass	CLEAR
		V6310-25-40 _ _	\$1,278	Brushed Nickel	CLEAR
		V6310-29-40 _ _	\$1,367	Oil-Rubbed Bronze	CLEAR

*BASE	PRICE	COLOR	SIZE
*ABF3642-13K	\$660	Biscuit	36" x 42" x 2 3/4"
*ABF3642-18K	\$694	White	36" x 42" x 2 3/4"
<i>* Not compatible with alcove models or with return panels.</i>			
ABF3648-13K	\$713	Biscuit	36" x 48" x 2 3/4"
ABF3648-18K	\$678	White	36" x 48" x 2 3/4"
ABF3260-13K	\$791	Biscuit	32" x 60" x 3"
ABF3260-18K	\$754	White	32" x 60" x 3"
<i>Above bases are compatible with model V56310 only</i>			
ABF3660-13K	\$847	Biscuit	36" x 60" x 2 3/4"
ABF3660-18K	\$806	White	36" x 60" x 2 3/4"
<i>Above base is compatible with models V56310 and V56312</i>			
ABF3672-13K	\$936	Biscuit	36" x 72" x 2 3/4"
ABF3672-18K	\$891	White	36" x 72" x 2 3/4"

CONTINUED ON NEXT PAGE

ABF
Acrylic Base



ABF3260
Acrylic Base



• ADDITIONAL RETURN PANEL SIZES ARE AVAILABLE. CONTACT CUSTOMER SERVICE FOR DETAILS.

SELECT OPTIONS

*SEE BASE SECTION FOR ADDITIONAL COMPATIBLE SHOWER MODELS AND TECHNICAL SPECIFICATIONS

Insert Code L or R

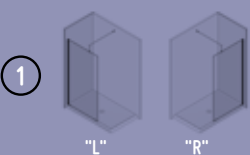

Insert Code H (flat) or Y (round) to select OPTIONAL TOWEL BAR



Towel Bar installs onto a panel

Available in two finishes:
CHROME - Surcharge \$215
BRUSHED - Surcharge \$200





5' AND 6' WALK-IN SHOWER SYSTEM



5' AND 6' WALK-IN SHOWER SYSTEM (CONT'D)

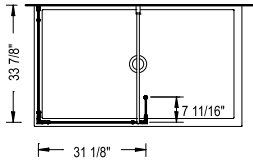

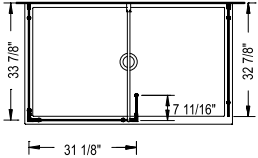
3/8" (10 mm) Clear Tempered Glass • 75" H (82 3/16" to top of support bar)

DIMENSIONS		MODEL	PRICE	FINISH	GLASS
 		V56307-11-40 ①-③	\$1,643	Bright Chrome	CLEAR
		V56307-12-40 _ _	\$1,664	Bright Brass	CLEAR
		V56307-25-40 _ _	\$1,764	Brushed Nickel	CLEAR
		V56307-29-40 _ _	\$1,897	Oil-Rubbed Bronze	CLEAR
 		V56308-11-40 ①-③	\$2,086	Bright Chrome	CLEAR
		V56308-12-40 _ _	\$2,107	Bright Brass	CLEAR
		V56308-25-40 _ _	\$2,207	Brushed Nickel	CLEAR
		V56308-29-40 _ _	\$2,377	Oil-Rubbed Bronze	CLEAR

*BASE	PRICE	COLOR	SIZE
*ABF3642-13K	\$694	Biscuit	36" x 42" x 2 3/4"
*ABF3642-18K	\$660	White	36" x 42" x 2 3/4"
<i>* Not compatible with alcove models or with return panels.</i>			
ABF3660-13K	\$847	Biscuit	36" x 60" x 2 3/4"
ABF3660-18K	\$806	White	36" x 60" x 2 3/4"
ABF3672-13K	\$936	Biscuit	36" x 72" x 2 3/4"
ABF3672-18K	\$891	White	36" x 72" x 2 3/4"

ABF
Acrylic Base

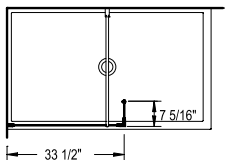

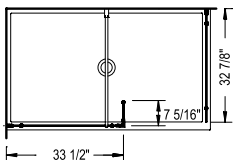
DIMENSIONS		MODEL	PRICE	FINISH	GLASS
 		V56314-11-40 ①-③	\$1,088	Bright Chrome	CLEAR
		V56314-12-40 _ _	\$1,110	Bright Brass	CLEAR
		V56314-25-40 _ _	\$1,166	Brushed Nickel	CLEAR
		V56314-29-40 _ _	\$1,255	Oil-Rubbed Bronze	CLEAR
 		V56315-11-40 ①-③	\$1,521	Bright Chrome	CLEAR
		V56315-12-40 _ _	\$1,542	Bright Brass	CLEAR
		V56315-25-40 _ _	\$1,599	Brushed Nickel	CLEAR
		V56315-29-40 _ _	\$1,709	Oil-Rubbed Bronze	CLEAR

*BASE	PRICE	COLOR	SIZE
ABF3642-13K	\$660	Biscuit	36" x 42" x 2 3/4"
ABF3642-18K	\$694	White	36" x 42" x 2 3/4"
<i>* Not compatible with alcove models or with return panels.</i>			
ABF3648-13K	\$713	Biscuit	36" x 48" x 2 3/4"
ABF3648-18K	\$678	White	36" x 48" x 2 3/4"
ABF3260-13K	\$791	Biscuit	32" x 60" x 3"
ABF3260-18K	\$754	White	32" x 60" x 3"
<i>Above bases are compatible with model V56314 only</i>			
ABF3660-13K	\$847	Biscuit	36" x 60" x 2 3/4"
ABF3660-18K	\$806	White	36" x 60" x 2 3/4"
ABF3672-13K	\$936	Biscuit	36" x 72" x 2 3/4"
ABF3672-18K	\$891	White	36" x 72" x 2 3/4"

ABF
Acrylic Base



ABF3260
Acrylic Base



• ADDITIONAL RETURN PANEL SIZES ARE AVAILABLE. CONTACT CUSTOMER SERVICE FOR DETAILS.

SELECT OPTIONS

Insert Code L or R

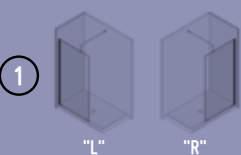

Insert Code H (flat) or Y (round) to select OPTIONAL TOWEL BAR

Towel Bar installs onto a panel

Available in two finishes:
CHROME - Surcharge \$215
BRUSHED - Surcharge \$200

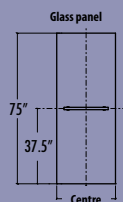

*SEE BASE SECTION FOR ADDITIONAL COMPATIBLE SHOWER MODELS AND TECHNICAL SPECIFICATIONS



6' WALK-IN SHOWER SYSTEM



6' WALK-IN SHOWER SYSTEM (CONT'D)

3/8" (10 mm) Clear Tempered Glass • 75" H (82 3/16" to top of support bar)

	DIMENSIONS	MODEL	PRICE	FINISH	GLASS
		V6302-11-40 ①-③	\$1,909	Bright Chrome	CLEAR
		V6302-12-40 _ _	\$1,931	Bright Brass	CLEAR
		V6302-25-40 _ _	\$2,063	Brushed Nickel	CLEAR
		V6302-29-40 _ _	\$2,207	Oil-Rubbed Bronze	CLEAR
		V6301-11-40 ①-③	\$1,505	Bright Chrome	CLEAR
		V6301-12-40 _ _	\$1,527	Bright Brass	CLEAR
		V6301-25-40 _ _	\$1,659	Brushed Nickel	CLEAR
		V6301-29-40 _ _	\$1,783	Oil-Rubbed Bronze	CLEAR
		V6303-11-40 ①-③	\$2,383	Bright Chrome	CLEAR
		V6303-12-40 _ _	\$2,405	Bright Brass	CLEAR
		V6303-25-40 _ _	\$2,538	Brushed Nickel	CLEAR
		V6303-29-40 _ _	\$2,726	Oil-Rubbed Bronze	CLEAR

*BASE	PRICE	COLOR	SIZE
ABF3672-13K	\$936	Biscuit	36" x 72" x 2 3/4"
ABF3672-18K	\$891	White	36" x 72" x 2 3/4"

ABF
Acrylic Base



CONTINUED ON NEXT PAGE

• ADDITIONAL RETURN PANEL SIZES ARE AVAILABLE. CONTACT CUSTOMER SERVICE FOR DETAILS.

SELECT OPTIONS

Insert Code L or R

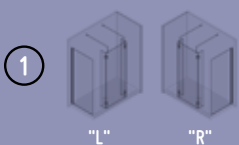

Insert Code H (flat) or Y (round) to select OPTIONAL TOWEL BAR

③

Towel Bar installs onto a Return Panel

Available in two finishes:
CHROME - Surcharge \$215
BRUSHED - Surcharge \$200

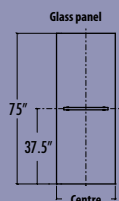

*SEE BASE SECTION FOR ADDITIONAL COMPATIBLE SHOWER MODELS AND TECHNICAL SPECIFICATIONS



6' WALK-IN SHOWER SYSTEM



6' WALK-IN SHOWER SYSTEM (CONT'D)

3/8" (10 mm) Clear Tempered Glass • 75" H (82 3/16" to top of support bar)

ROUND TOP	SQUARE TOP	DIMENSIONS	ROUND MODEL	SQUARE MODEL	PRICE	FINISH	GLASS
			V6305-11-40 ①-②	VW6305-11-40 ①-②	\$1,793	Bright Chrome	CLEAR
			V6305-12-40 _ _	VW6305-12-40 _ _	\$1,815	Bright Brass	CLEAR
			V6305-25-40 _ _	VW6305-25-40 _ _	\$1,982	Brushed Nickel	CLEAR
			V6305-29-40 _ _	VW6305-29-40 _ _	\$2,126	Oil-Rubbed Bronze	CLEAR
			V6306-11-40 ①-②③	VW6306-11-40 ①-②③	\$2,270	Bright Chrome	CLEAR
			V6306-12-40 _ _	VW6306-12-40 _ _	\$2,292	Bright Brass	CLEAR
			V6306-25-40 _ _	VW6306-25-40 _ _	\$2,469	Brushed Nickel	CLEAR
			V6306-29-40 _ _	VW6306-29-40 _ _	\$2,647	Oil-Rubbed Bronze	CLEAR
			V6308-11-40 ①-②③	VW6308-11-40 ①-②③	\$2,747	Bright Chrome	CLEAR
			V6308-12-40 _ _	VW6308-12-40 _ _	\$2,769	Bright Brass	CLEAR
			V6308-25-40 _ _	VW6308-25-40 _ _	\$2,957	Brushed Nickel	CLEAR
			V6308-29-40 _ _	VW6308-29-40 _ _	\$3,179	Oil-Rubbed Bronze	CLEAR

Shown with optional Towel Bar

*BASE	PRICE	COLOR	SIZE
ABF3672-13K	\$936	Biscuit	36" x 72" x 2 3/4"
ABF3672-18K	\$891	White	36" x 72" x 2 3/4"

ABF
Acrylic Base



CONTINUED ON NEXT PAGE

• ADDITIONAL RETURN PANEL SIZES ARE AVAILABLE. CONTACT CUSTOMER SERVICE FOR DETAILS.

SELECT OPTIONS

*SEE BASE SECTION FOR ADDITIONAL COMPATIBLE SHOWER MODELS AND TECHNICAL SPECIFICATIONS

Insert Code L or R

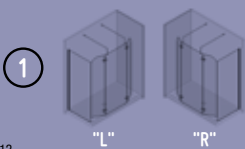

Insert Code M, Q, T or R

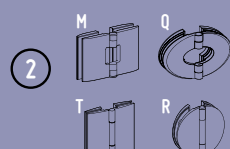

Insert Code H (flat) or Y (round) to select OPTIONAL TOWEL BAR

③

Towel Bar installs onto a panel

Available in two finishes:
CHROME – Surcharge \$215
BRUSHED – Surcharge \$200

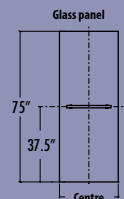

6' WALK-IN SHOWER SYSTEM



6' WALK-IN SHOWER SYSTEM (CONT'D)

3/8" (10 mm) Clear Tempered Glass • 75" H (82 3/16" to top of support bar)

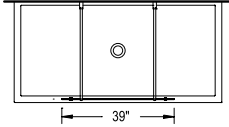
	DIMENSIONS	MODEL	PRICE	FINISH	GLASS
		V6309-11-40 ①-③	\$762	Bright Chrome	CLEAR
		V6309-12-40 _- _	\$785	Bright Brass	CLEAR
		V6309-25-40 _- _	\$829	Brushed Nickel	CLEAR
		V6309-29-40 _- _	\$895	Oil-Rubbed Bronze	CLEAR

*BASE	PRICE	COLOR	SIZE
*ABF3642-13K	\$660	Biscuit	36" x 42" x 2 3/4"
*ABF3642-18K	\$694	White	36" x 42" x 2 3/4"
<i>* Not compatible with alcove models or with return panels.</i>			
ABF3648-13K	\$713	Biscuit	36" x 48" x 2 3/4"
ABF3648-18K	\$678	White	36" x 48" x 2 3/4"
ABF3260-13K	\$791	Biscuit	32" x 60" x 3"
ABF3260-18K	\$754	White	32" x 60" x 3"
ABF3660-13K	\$847	Biscuit	36" x 60" x 2 3/4"
ABF3660-18K	\$806	White	36" x 60" x 2 3/4"
ABF3672-13K	\$936	Biscuit	36" x 72" x 2 3/4"
ABF3672-18K	\$891	White	36" x 72" x 2 3/4"

ABF
Acrylic Base



ABF3260
Acrylic Base



Support bar dimensions

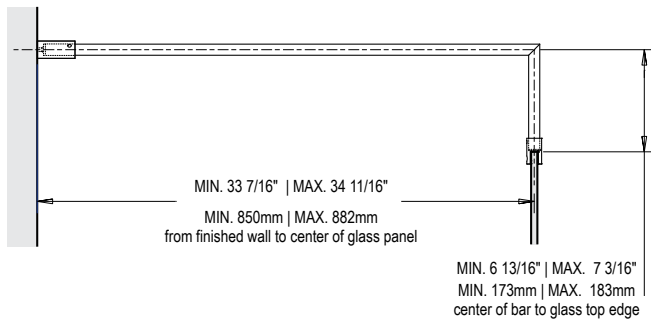

SELECT OPTIONS

Insert Code H (flat) or Y (round) to select OPTIONAL TOWEL BAR

3

Towel Bar installs onto a front Panel

Available in two finishes:
CHROME - Surcharge \$215
BRUSHED - Surcharge \$200

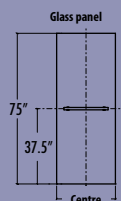

*SEE BASE SECTION FOR ADDITIONAL COMPATIBLE SHOWER MODELS AND TECHNICAL SPECIFICATIONS



MODEL V6636-11-40R



79" H (86 13/16" to top of support bar) • Approximate opening - 22"

MODEL	PRICE	FINISH	GLASS
5/16" (8 mm) Clear Tempered Glass			
V6636-11-40 ①	\$1,095	Bright Chrome	CLEAR
V6636-12-40 _	\$1,118	Bright Brass	CLEAR
V6636-25-40 _	\$1,172	Brushed Nickel	CLEAR
V6636-29-40 _	\$1,262	Oil-Rubbed Bronze	CLEAR

*BASE	PRICE	COLOR	DRAIN	SIZE
ABSL66-18LK	\$864	White	Left side	66" x 38" x 5"
ABSL66-18RK	\$864	White	Right side	66" x 38" x 5"

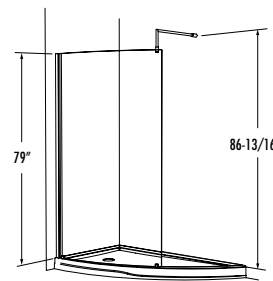

ABSL66-18LK
Left-side Acrylic Base



ABSL66-18RK
Right-side Acrylic Base

*SEE BASE SECTION FOR ADDITIONAL COMPATIBLE SHOWER MODELS.

Insert Code L or R

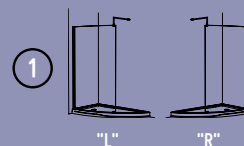

Microtek
by Fleurco
Glass surface protection.
See information sheet at the end of this section for ordering details.

Microtek Glass Protector



Protect your shower glass and extend its life by choosing Microtek, Fleurco's unique water repellent coating. Microtek uses the latest technology to offer easy maintenance and a hygienic environment. Microtek protects your glass for up to ten years.

COMPARED WITH ORDINARY GLASS, MICROTEK:

- Resists staining from hard water deposits.
- Is easier to clean.
- Does not support the growth of bacteria.
- Eliminates the need for harsh and abrasive cleaning products.

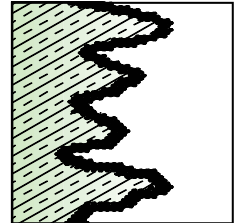

YOUR GLASS PROTECTED WITH MICROTEK

- Saves time and effort.
- Stays cleaner longer.
- Creates a more hygienic environment.



PRECAUTIONS

- Avoid using abrasive cleaners.
- Hydrofluoric and phosphoric acid can damage glass surface and should not be used.
- Do not use abrasive scouring powders or pads, highly acidic/alkaline cleaners, brushers, razor blades or other sharp objects which may scratch or harm the glass surface.

MAINTENANCE

A soft cloth is all you need to clean your protected glass. For best results, squeegee dry after each use.

ORDER INFORMATION

WHEN ORDERING A DOOR WITH MICROTEK:

- Must be on a separate P.O.
- P.O. must contain the Item Number.
- On a separate line it must be marked with Microtek code (CS-1) and Left or Right as per the information / product line below.
- \$ 150 / panel.

PLATINUM

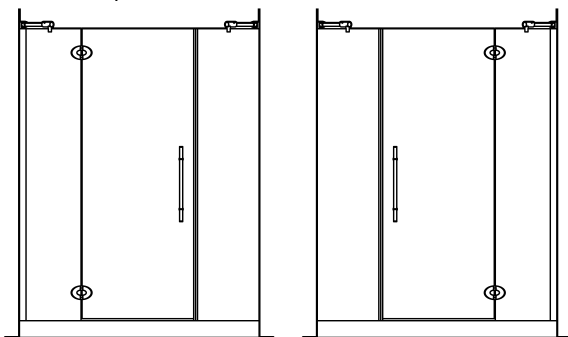

L

R

THE HINGES ARE INSTALLED ON LEFT SIDE OF DOOR AS VIEWED FROM THE EXTERIOR

THE HINGES ARE INSTALLED ON RIGHT SIDE OF DOOR AS VIEWED FROM THE EXTERIOR

EVOLUTION*

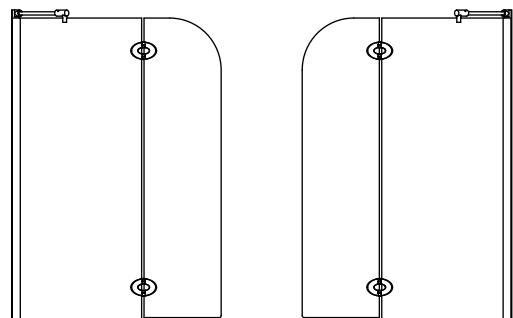

L

R

THE HINGES ARE INSTALLED ON LEFT SIDE OF PANEL AS VIEWED FROM THE EXTERIOR

THE HINGES ARE INSTALLED ON RIGHT SIDE OF PANEL AS VIEWED FROM THE EXTERIOR

EXAMPLE

LIST

Model # PXT57-11-40	\$ 1 933.00
CS-1 (3 PANELS / 1 SIDE) Specify L or R (see above)	\$ 450.00

EXAMPLE

LIST

Model # VXSH24-11-40	\$ 1 171.00
CS-1 (2 PANELS / 1 SIDE) Specify L or R (see above)	\$ 300.00

DURABILITY GUIDELINES

MICROTEK IS EXPECTED TO PERFORM FOR UP TO

10 YEARS

WARRANTY

Provided the glass is maintained according to published after-care instructions and without the use of abrasive cleaning methods or highly alkaline products, FLEURCO warrants that Microtek will work for up to ten (10) years from the date of application.