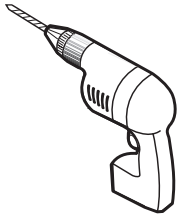
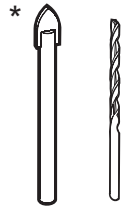


## TOOLS REQUIRED / OUTILS REQUIS



**DRILL**  
PERCEUSE



**1/4" & 1/8" DRILL BITS**  
MÈCHES 1/4" & 1/8"



**SCREWDRIVER**  
TOURNEVIS



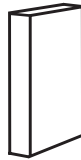
**SCREWDRIVER**  
TOURNEVIS



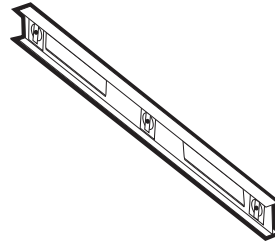
**PENCIL**  
CRAYON



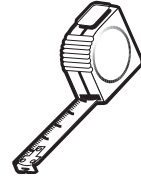
**SUPER GLUE**  
COLLE FORTE



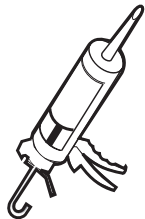
**BLOCK**  
BLOC



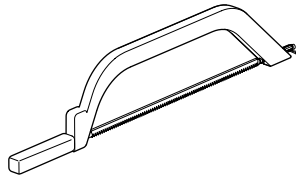
**LEVEL**  
NIVEAU



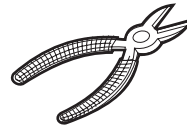
**TAPE MEASURE**  
RUBAN À MESURER



**SILICONE**  
SCÉLANT



**HACKSAW**  
SCIE À MÉTAUX



**CUTTING PLIERS**  
PINCE COUPANTE

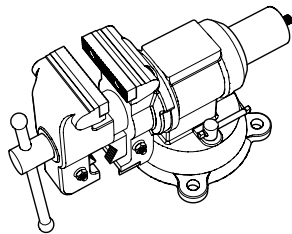


**MALLET**  
MAILLET

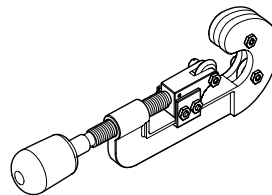
\* Use a 1/4" drill bit when drilling into ceramic tiles

\* Utiliser une mèche de 1/4" pour percer des tuiles en céramique.

## TOOLS REQUIRED TO CUT THE RUNNING RAIL OUTILS REQUIS POUR COUPER LA BARRE DE ROULEMENT

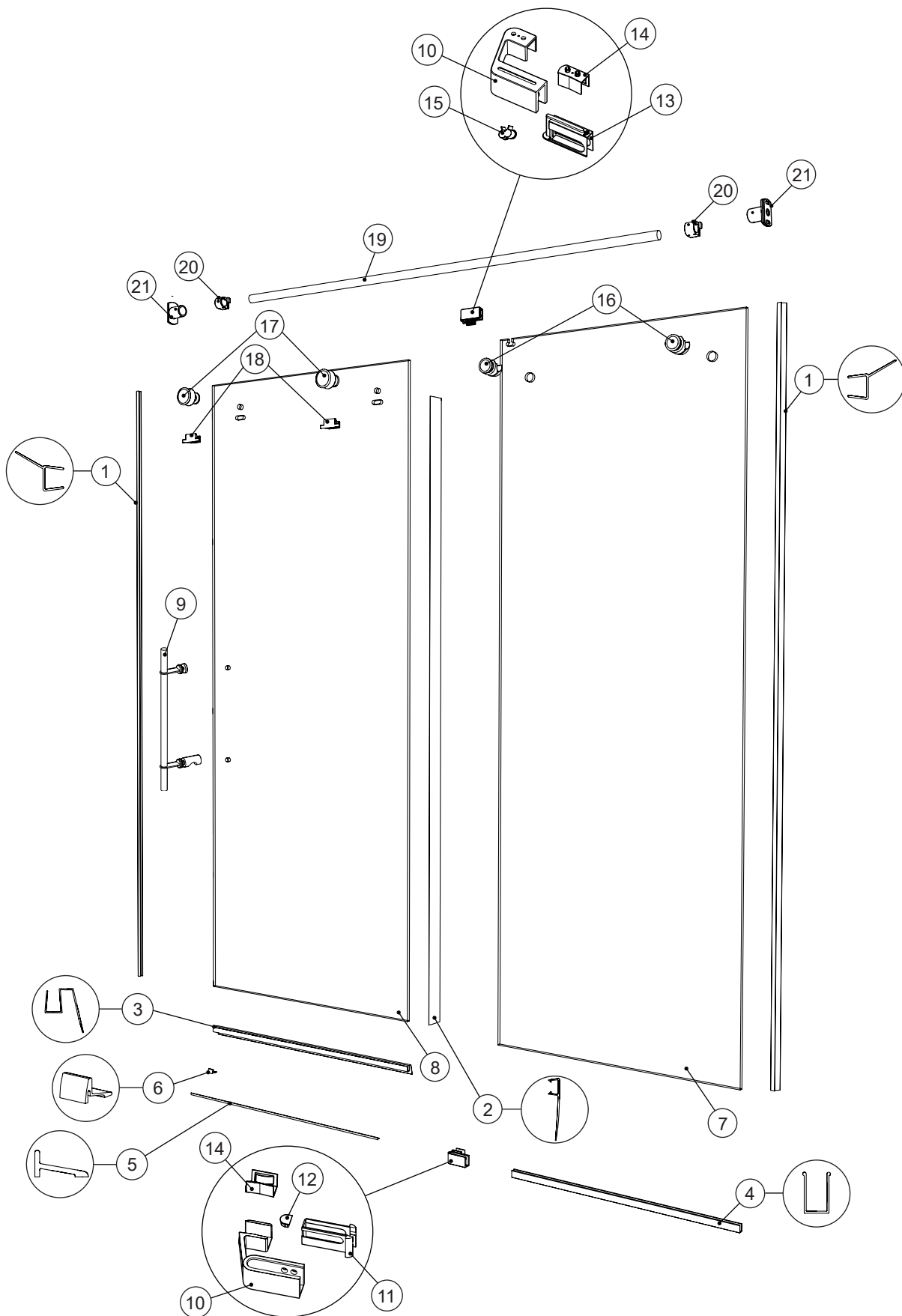


**TABLE VISE**  
ÉTAU DE TABLE

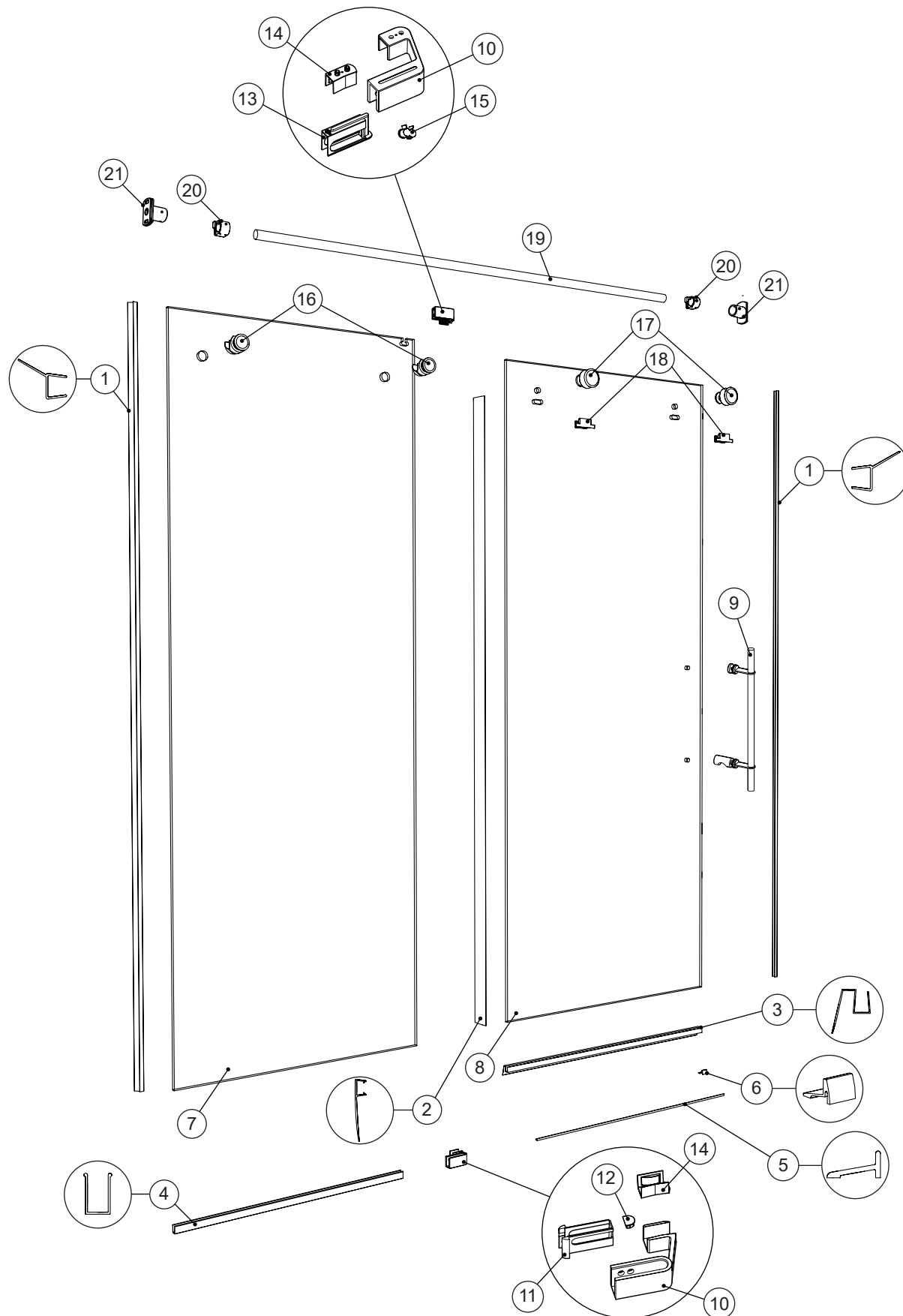


**TUBE CUTTER WITH CUTTER WHEEL FOR STAINLESS  
STEEL (TUBE DIAMETER : 1" / 25.4mm)**  
COUPE-TUBE AVEC UNE ROUE COUPANTE POUR ACIER  
INOXYDABLE (DIAMÈTRE DU TUBE: 1" / 25.4mm)

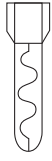
K2AS \_ \_ -40L



K2AS\_\_-\_\_-40R



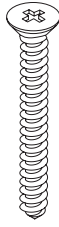
**PARTS LISTING / LISTE DES PIÈCES**



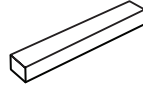
22



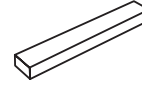
23



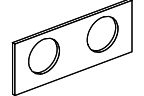
24



25



26



27

ITEM	FLEURCO CODE	PARTS AND HARDWARE / PIÈCES ET QUINCAILLERIE	QTY
1	COEX K120-80	SIDE GASKET / JOINT DE CÔTÉ	2
2	COEX K330-80	MID GASKET / JOINT LATÉRAL	1
3	COEX K130-72	BOTTOM DOOR GASKET / JOINT INFÉRIEUR DE LA PORTE	1
4	++15410-10-80	U-CHANNEL / PROFILÉ EN "U"	1
5	++15405	THRESHOLD / SEUIL	1
6	PENDCAP-XX	THRESHOLD ANCHOR / ANCRAGE DU SEUIL	1
7		FIXED PANEL / PANNEAU FIXE	1
8		DOOR PANEL / PANNEAU DE PORTE	1
9	HANDLE XX-16S	HANDLE / POIGNÉE	1
10	K2GUIDESET-XX-R2	GUIDE / GUIDE	2
11		BOTTOM SLEEVE / GAINÉ PROTECTRICE INFÉRIEURE	1
12		GUIDE CAP / CAPUCHON DU GUIDE	1
13		TOP SLEEVE / GAINÉ PROTECTRICE SUPÉRIEURE	1
14		PLASTIC GUIDE / GUIDE EN PLASTIQUE	2
15		SCREW INSERT / INSERT DE VIS	1
16	K2FASTENER-XX	GLASS FASTENER / FIXATION DE VERRE	2
17	K2ROLLER-R1	ROLLER / ROULETTE	2
18	K2STRIKER-XX	ANTI-JUMP / ANTI-SAUT	2
19	K2BARXX-60C	RUNNING RAIL / BARRE DE ROULEMENT	1
20	K2STOPPER-XX	STOPPER / BUTOIR	2
21	KTWBRACKET2-XX	WALL BRACKET / SUPPORT MURAL	2
22		WALL PLUG / CHEVILLE	4
23		FLAT SELF-DRILLING SCREW #6 (1") / VIS PLAT AUTO-PERÇANTE # 6 (1")	1
24		FLAT HEAD SCREW #10 (2 1/2") / VIS À TÊTE PLATE # 10 (2 1/2")	4
25		CLEAR SETTING BLOCK (5/32") / BLOC NIVEAU TRANSPARENT (5/32")	4
26		CLEAR SETTING BLOCK (1/8") / BLOC NIVEAU TRANSPARENT (1/8")	4
27		ANTI-JUMP SHIM / CALE POUR L'ANTI-SAUT	2

**LEGEND / LÉGENDE**

XX = FINISH/FINI (11, 35, 12)  
 \*\* = LENGTH / LONGUEUR (54, 60, 79, 86 ETC)  
 ++ = CODE / CODE (AC, ABN)